

metos

COMBI KETTLE CULINOPRO

Type (liter): 40, 60, 80, 100, 150, 200, 300, 400



4224500
4224502
4224504
4224506
4224508
4224510
4224512
4224514

Installation and Operation Manual

Original instructions

Rev. 1.0 (14.3.2025) From 30.12.2024

TABLE OF CONTENTS

1.	General	4
1.1.	Symbols used in the manual	4
1.2.	Symbols used on the appliance	4
1.3.	Checking the relationship of the appliance and the manual	4
2.	Safety	5
2.1.	General	5
2.2.	Construction of the combi-kettle	6
2.3.	Changing the settings and adjustments	7
2.4.	Safety instructions in the event of malfunction	7
2.5.	Disposal of the appliance	7
2.6.	Other prohibitions (dangerous methods and procedures)	7
3.	Functional description	8
3.1.	Intended use of the appliance	8
3.1.1.	Use for other purposes	8
3.2.	Construction	8
3.3.	Operating principle	8
3.4.	Display	9
3.4.1.	Display when the appliance is in stand-by mode	9
3.4.2.	The display elements (basic functions)	10
4.	Operating instructions	14
4.1.	Before use	14
4.1.1.	Positioning the mixing tool and scrapers	14
4.2.	Using the kettle	16
4.2.1.	Heating	16
4.2.2.	Cooling	17
4.2.3.	Mixer functions	19
4.2.4.	Tilting the kettle	20
4.2.5.	Water filling	20
4.2.6.	Timer ("egg timer")	21
4.3.	After use	22
4.3.1.	Cleaning	22
4.3.2.	Periodic service	24
4.3.3.	Safety valve test	24
4.4.	Troubleshooting	25
4.4.1.	Maintenance information	26
5.	Adjustment instructions	27
5.1.	Changing the settings without logging	27
5.1.1.	Fresh water function	27
5.1.2.	Memory functions	28
5.1.3.	Teach mode	28
5.1.4.	Language	28
5.1.5.	Time and date	28
5.1.6.	Sounds	28
5.1.7.	Safety valve test	28
5.1.8.	Version info	28
5.1.9.	Use of electricity and water	28
5.2.	Changing the settings that require logging in as chef	29
5.2.1.	Memory functions	29
5.2.2.	Sounds	29

5.2.3.	Parameters	30
6.	Installation	31
6.1.	General	31
6.1.1.	Operating conditions	31
6.1.2.	Possible interference from the surroundings (to the surroundings)	31
6.1.3.	Storage	31
6.1.4.	Unpacking the appliance	31
6.1.5.	Disposal of the package	31
6.2.	Installation	32
6.2.1.	Floor-mounted kettles (FM)	32
6.3.	Residual current device recommendation	32
6.4.	Installation frames	33
6.4.1.	Positioning of installation frames	33
6.4.2.	Subsurface frame cast into the floor	34
6.4.3.	Surface installation frame fixed to the floor	35
6.5.	Installation on frames	36
6.6.	Free standing kettles	38
6.7.	Electrical connections	42
6.7.1.	Electrical connection to peak power regulating systems	44
6.7.2.	Forced half power	45
6.8.	Water connections	47
6.8.1.	Water connection and quality requirements	48
6.8.2.	Extreme water conditions	49
6.9.	Ventilation	50
6.10.	Other installations	50
6.11.	Procedures after installation	50
6.11.1.	Adjusting the tilting	50
6.11.2.	Fastening the mixer motor cover box	52
6.11.3.	Adjusting the safety lid	52
6.12.	First run and testing	53
6.12.1.	Filling the steam generator	53
6.12.2.	Safety valve test	53
6.12.3.	Earth leakage circuit breaker test (option)	54
6.13.	Adjustments, programming	54
6.14.	Staff training	54
7.	Technical specifications	55
7.1.	Dimensions	55
7.3.	Water connection	56
7.2.	Floor drain and installation frame positioning	56
7.4.	Electrical connections	57
8.	Spare parts not covered by warranty	57
	Installation/commissioning checklist	59

1. General

Carefully read the instructions in this manual as they contain important information regarding proper, efficient and safe installation, use and maintenance of the appliance.

Keep this manual in a safe place for eventual use by other operators of the appliance.

The installation of this appliance must be carried out in accordance with the manufacturer's instructions and following local regulations. The connection of the appliance to the electric and water supply must be carried out by qualified persons only.

Persons using this appliance should be specifically trained in its operation.

Switch off the appliance in the case of failure or malfunction. The periodical function checks requested in the manual must be carried out according to the instructions. Have the appliance serviced by a technically qualified person authorized by the manufacturer and using original spare parts.

Not complying with the above may put the safety of the appliance in danger.

1.1. Symbols used in the manual



This symbol informs about a situation where a safety risk might be at hand. Given instructions are mandatory in order to prevent injury.



This symbol informs about the right way to perform in order to prevent bad results, appliance damage or hazardous situations.



This symbol informs about recommendations and hints that help to get the best performance out of the appliance.

1.2. Symbols used on the appliance



This symbol on a part informs about electrical terminals behind the part. The removal of the part must be carried out by qualified persons only.

1.3. Checking the relationship of the appliance and the manual

The rating plate of the appliance indicates the serial number of the appliance. If the manuals are missing, it is possible to order new ones from the manufacturer or the local representative. When ordering new manuals it is essential to quote the serial number shown on the rating plate.

If language versions have information contradictions, the original language English is the primary language regarding the information content.

2. Safety

2.1. General

The appliance is CE marked, which means that it complies with the requirements of the EU machinery directive with regard to product safety.

Product safety means that the design of the appliance will prevent personal injury or damage to property.

The CulinoPro combi-kettle has been designed and manufactured in compliance with the Directive regarding safety of Machinery, the Low Voltage Directive, the Directive regarding Electromagnetic Compatibility and the Directive regarding Pressure Equipment currently in force.

The CulinoPro combi-kettle is a pressurized vessel with a maximum operating pressure of 1 bar (or 0,5 bar for certain markets). Overpressure is prevented by means of both mechanical (safety valve, pressure switch) and electronic control.

The CulinoPro combi-kettle is provided with water level control, which prevents heating if there is not enough water in the steam generator.



Modifying the equipment without the approval of the manufacturer invalidates the manufacturer's product liability.



To further improve safety during installation, operation and servicing, the operator and the personnel responsible for installing and servicing the appliance should read the safety instructions carefully.



Switch off the appliance immediately in the event of a fault or malfunction. The appliance must only be serviced by trained engineers. The regular checks described in the manual must be carried out in accordance with the instructions. The appliance must be serviced by a person authorized to do so by the manufacturer. Use original spare parts. Dangerous situations may arise if the instructions above are not followed.



Before using the appliance, ensure that personnel are given the necessary training in operating and maintaining the appliance.



Keep this manual in a safe place so that it can be used by other operators of the appliance.

This manual guides the user to use the device safely.



Carefully read the instructions in this manual as they contain important information regarding proper, efficient and safe installation, use and maintenance of the appliance.



The appliance should not be used by anyone suffering from a physical or mental illness or by inexperienced people (including children).



Children should be watched to ensure that they do not play with the appliance.



The manufacturer does not take any responsibility for possible damage caused by incorrect use of the device or not following the instructions.



Keep the touch screen clean.



Do not open the drain valve of the steam jacket until the pressure has been reduced to approximately atmospheric pressure.



Opening the drain valve of the steam jacket will lead to the outflow of the hot contents.



These appliances are intended to be used for commercial applications, for example in kitchens of restaurants, canteens, hospitals and in commercial enterprises such as bakeries, butcheries, production kitchens, etc., but not for continuous mass production of food.

2.2. Construction of the combi-kettle

The main parts of the combi-kettle are illustrated in the following pictures:



1. Control pillar
2. Support pillar
3. Safety block
4. Mixer and mixing tool
5. Emptying valve for steam generator / steam jacket
6. Safety lid
7. Safety grid for fill opening
8. Control panel
9. Emergency/stop button
10. Water fill to kettle
11. Free standing frame (option)

**Lid**

1. Safety lid
2. Lifting arm
3. Locking lever of the lid
4. Safety grid for fill opening
5. Safety switch
6. Cover for fill opening (not shown in picture)

**Mains switch**

1. Mains switch

2.3. Changing the settings and adjustments

Technical adjustments to the appliance must be performed by a qualified and well trained person.

2.4. Safety instructions in the event of malfunction

In case of a serious emergency, all functions of the appliance must be stopped by turning the mains switch to the OFF position. In case the reason for using the stop switch is a serious malfunction jeopardizing safety at work, contact an authorized service provider immediately.

2.5. Disposal of the appliance

Once the appliance has reached the end of its useful life, it must be disposed of in compliance with local rules and regulations. The appliance may contain substances/ materials which potentially have an adverse impact on the environment as well as recyclable materials. The best way of dealing with such substances is to dispose of them through a proper waste company.

2.6. Other prohibitions (dangerous methods and procedures)

Deliberate disregard of safety devices is prohibited, as it jeopardizes safe work in the kitchen. The manufacturer does not take responsibility for damage caused by deliberate use of a defective appliance, disregard of the safety precautions by modifying the designed operation of the appliance, or neglect of the technical condition, maintenance or service of the appliance.

3. Functional description

3.1. Intended use of the appliance

The CulinoPro combi-kettle is designed for professional food preparation. Using CulinoPro for other purposes is prohibited. It is forbidden to put corrosive ingredients or substances reacting with each other in the kettle. Please observe that long-term effect of some substances used in food preparation is corrosive. Such substances are, for example, salt, acetic acid, citric acid and lactic acid.

The corrosion resistance of stainless steel is due to a so called passive layer, which is a very thin chromium oxide film. This film is naturally and fairly quickly formed on the stainless steel surface when the surface is in contact with oxygen (air). The chromium oxide film is hard, but in some situations it is possible to damage it with hard materials. When using steel tools, there is a potential risk of scratching the inner jacket and hence increased risk of corrosion. Therefore, we recommend using wooden or plastic tools in the kettle, especially when mixing and scraping.

3.1.1. Use for other purposes



The manufacturer does not take responsibility for functional troubles or damages caused by misuse or use for other purposes than stated above.

3.2. Construction

The construction of the kettle is of stainless steel throughout. The inner bottom and jacket are of acid-proof steel. The kettle is triple-jacketed and thermally insulated throughout.

3.3. Operating principle

The CulinoPro kettle is heated by steam generated with heating elements. The steam generator and heating elements are located in the lower section of the kettle.

The kettle tilts by means of a tilting motor (40 - 150 -liter kettles). Larger kettles (200 - 400 liters) are equipped with a hydraulic tilting mechanism. The mixing functions are performed by means of a gear motor. Cooling (accessory) is based on cold water circulating inside the kettle's steam jacket. The raised control panel of the appliance is situated on the kettle's right-hand pillar (control pillar).

3.4. Display

3.4.1. Display when the appliance is in stand-by mode

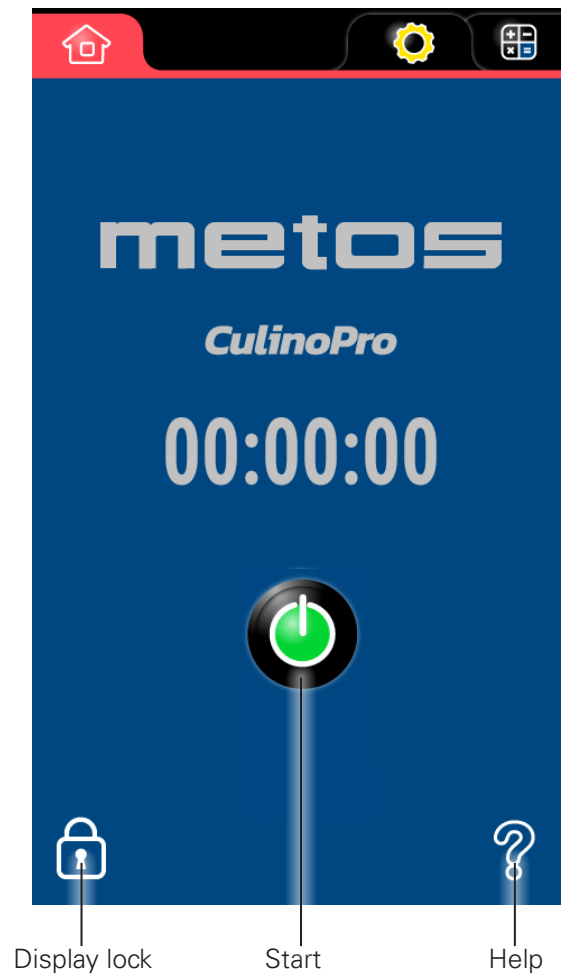

Screen saver. The screen saver is activated when the display has been idle for a set amount of time. The display goes black or starts to show the time or the possible active functions. The display will return to normal operation when touching it.

3.4.2. The display elements (basic functions)



1. Tabs



2. Info

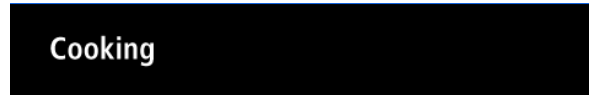

3. Temperature functions

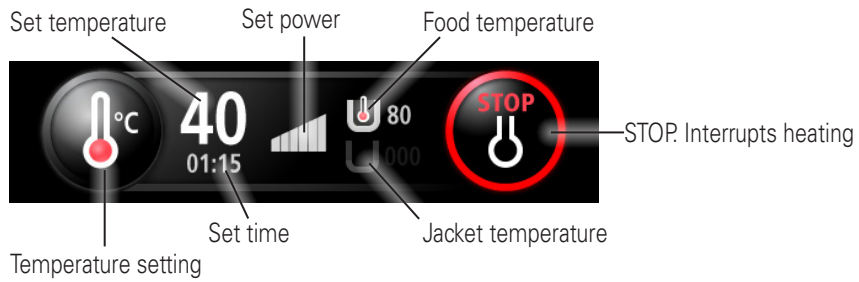

4. Mixer functions

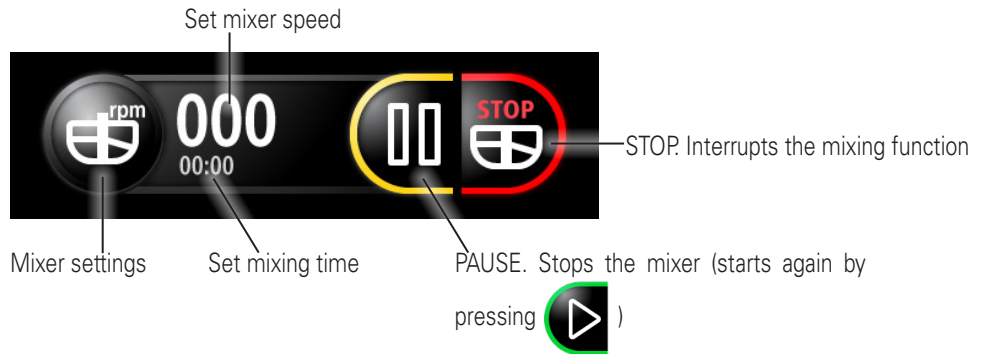

5. Timer functions ("egg timer")

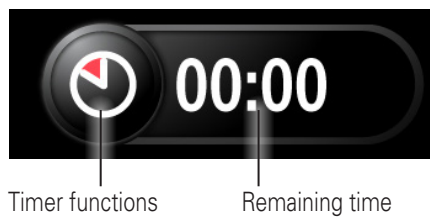

6. Water filling function

Set amount (liters)* Achieved amount (liters)*

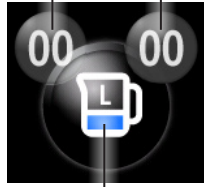

Automatic water filling.



Canceling the automatic water filling*

Achieved amount (liters)*

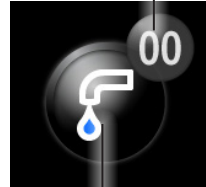

Manual water filling.



Canceling the manual water filling*

* Only displayed during water filling

7. Bowl tilting functions



Return kettle bowl to upright position ( = bowl in cooking position).

Kettle bowl tilting ( = bowl fully tilted).



In the case of electrically heated kettles, after switching off the heating, you should wait about 5 seconds before tilting the kettle. Immediate tilting will shorten the life of the heating elements.

8. Navigation



ON/OFF

Stop

Help

Info

A short press on the Help button shows the help for that view. A long press on the Help button locks the screen. When the screen is locked, the Help button becomes the lock button. A long press on the lock button unlocks the screen.

Other symbols on the display:



Return to previous display.



Home. On any page, push the button to go to the main view.









Emptying the jacket.



The Hold function (cooling) is active.

Keypad functions

In connection with various settings, a keypad will appear on the display:

- Push the uppercase button  to toggle between lowercase , uppercase  and uppercase hold letters.  (caps lock).
- Push the backspace button  to erase characters.
- Push the special characters button  for numbers and special characters.



4. Operating instructions



All personnel using the appliance must be given training in how the appliance works by the person responsible for staff safety.

4.1. Before use

Before using the kettle for the first time or if it has not been used for a long time

Clean the kettle throughout with a warm detergent solution, wiping to remove dust and contaminants from the kettle surfaces. Then dry the surfaces.

Daily checks before use

- Water supply (hot/cold) is open.
- No inappropriate objects in the kettle.
- Scrapers are correctly attached to the mixing tool. See "Positioning the mixing tool and scraper".
- The mixing tool has been locked in its place: locking part (one end of the handle) in the groove of the mixer axle, with the handle turned in a horizontal position. Secure fixing by trying to lift the tool out of the kettle by the upper blade.
- The touch screen is clean.

4.1.1. Positioning the mixing tool and scrapers

Attach the scrapers by placing the pins on the mixing tool into the holes on the scrapers. After that turn the scraper into place by lifting the scraper's lower part. Finally pull the scraper forward. The bevel (1) will on the lower scraper point upwards and on the side scraper away from the mixer axle.

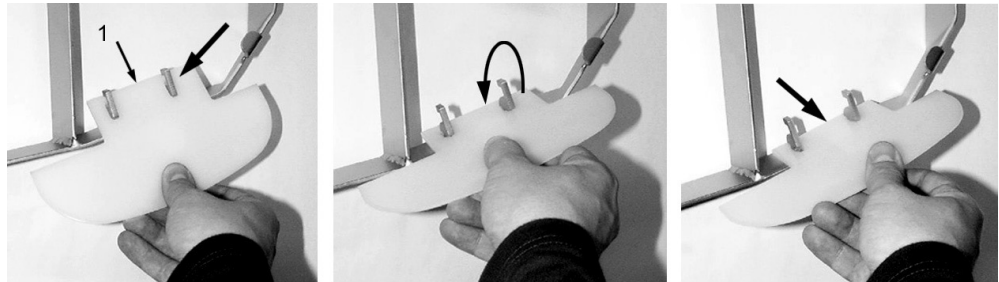

The mixing tool is equipped with 1-5 scrapers, depending on the size of the tool.

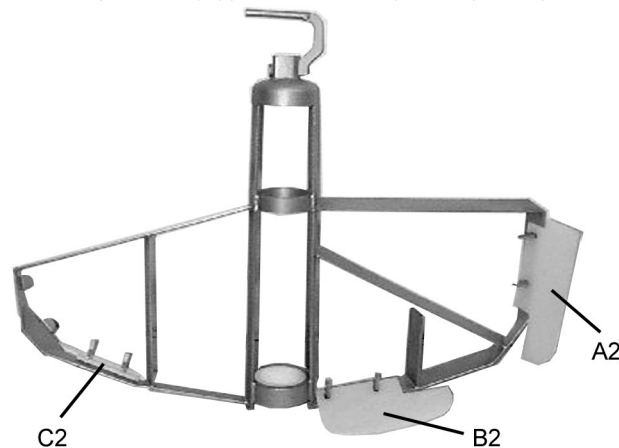

Scraper	40	60	80	100	150	200	300	400
Scraper A2	-	1	1	2	1	2	1	2
Scraper B2	-	-	1	1	1	1	1	1
Scraper C2	1	1	-	-	1	1	2	2

Use scrapers in all cooking modes to increase the efficiency of heat transfer and to help the cleaning of the kettle.



It is easiest to attach the mixing tool to the mixer axle when the kettle is in a tilted position. Push the ring on the mixing tool into the kettle's mixer axle and fit the mixing tool in place, while the lifting handle is straight so that the locking device of the lifting handle sets in the groove at the upper end of the mixer axle.

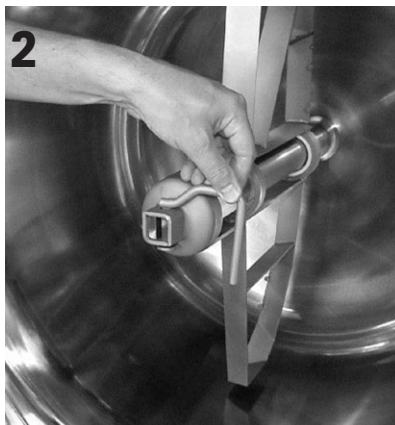

Then turn the handle aside.

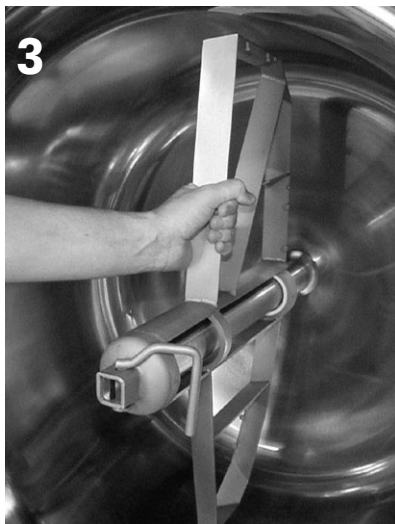

Make sure that the mixing tool is locked in its place by trying to lift/pull it out of its place by pulling at the mixer blade, for example.

4.2. Using the kettle

Switching on

- Activate the display if it is dark by touching it.
 - Check the power supply if the display is not activated. Ensure that the main switch on the kettle back is set in state "1".
- Start the kettle by pressing . The display will show the basic functions.

Switching off

- Put the kettle in stand-by mode by keeping  pressed.



NOTE: ALWAYS put the kettle in stand-by mode before switching off the power!

4.2.1. Heating

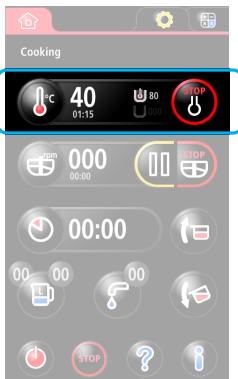

Heating is only switched on when the kettle is in upright position (cooking position). If the heating function is selected when the kettle is not in upright position, the message "Kettle not in cooking position" appears on the display. If the kettle is tilted while the heating is on, the heating will be interrupted. The heating is switched on again when the kettle is returned to upright position.



In the case of electrically heated kettles, after switching off the heating, you should wait about 5 seconds before tilting the kettle. Immediate tilting will shorten the life of the heating elements.

-  Press the heating button.
- Set the temperature using the keypad ( ... ) and start the heating by pressing .



Set the power with the power control:



Low power: The difference between the steam jacket temperature and the food temperature is smaller and the cooking is gentler. Suitable for example for heating milk.

High power: Fastest possible heating.

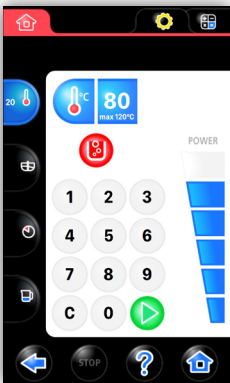

The heating starts, the display shows the set temperature  , the selected power level  , food temperature  and steam jacket temperature .

When the set temperature is reached, the message "Initial heating completed" appears on the display.

- Mute the possible audio signal by pressing  or confirm by pressing . The message disappears after a while if the display is not touched.



By pressing the "Boil" button  the boil function (100°C) starts automatically regardless of the set temperature.



The cook intensity can be adjusted with the power control by pressing the desired field .

The heating / cooking is stopped by pressing .





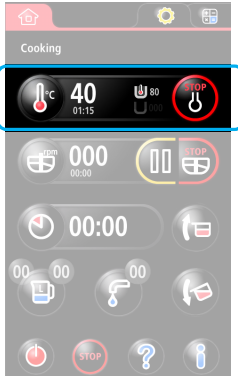

NOTE! Pressing  stops all kettle functions.

4.2.2. Cooling







i Cooling is only switched on when the kettle is in upright position (cooking position). If the heating function is selected when the kettle is not in upright position, the message "Kettle not in cooking position" appears on the display .

-  Press the temperature button.
- Press .
- Select "Hold"  or "Finish"  function.

Hold -function

The "Hold" function keeps the food at the set cooling temperature after the cooling until the user stops the function.

- Press the "Hold" button .
- Set the cooling temperature with the keypad.
- Start the cooling by pressing .
- Confirm the cooling by pressing .
- Using the mixer improves the efficiency of the cooling. Start the mixer by pressing . Adjust the mixer speed if needed.
- Exit the mixer view by pressing .

When the set temperature is reached, the message "Target cooling temperature reached" appears on the display.

- Mute the possible audio signal by pressing  or confirm by pressing . The message disappears after a while if the display is not touched.

After this, the Hold function will continue until the user stops the function.

- Stop the function by pressing .
 - The kettle jacket is emptied.

i **Do not set a too low cooling temperature! Take into account the cooling medium, for example tap water temperature. It is advisable to set the cooling temperature 2 degrees warmer than the tap water temperature. To achieve a lower temperature than that is in practice very difficult and may increase the water consumption considerably.**





i When the cooling is completed the kettle jacket is emptied and the remaining emptying time and  is shown on the display. **The kettle must be in cooking position in order for the water in the jacket to drain. It is therefore necessary to return the kettle to upright position after any tilting.** The emptying time depends on the kettle size.

i The function can be stopped by pressing .



i **NOTE! Pressing  stops all kettle functions.**

Finish -function

The "Finish" -function interrupts the cooling when the set cooling temperature is reached.



- Press the "Finish" button .
- Set the cooling temperature with the keypad.
- Start the cooling by pressing .
- Confirm the cooling by pressing .
- Using the mixer improves the efficiency of the cooling. Start the mixer by pressing . Adjust the mixer speed if needed.
- Exit the mixer view by pressing .

When the set temperature is reached, the message "Target cooling temperature reached" appears on the display.

- Mute the possible audio signal by pressing  or confirm by pressing . The message disappears after a while if the display is not touched.



 **Do not set a too low cooling temperature! Take into account the cooling medium, for example tap water temperature.**

It is advisable to set the cooling temperature 2 degrees warmer than the tap water temperature. To achieve a lower temperature than that is in practice very difficult and may increase the water consumption considerably.

 When the cooling is completed the kettle jacket is emptied and the remaining emptying time and  is shown on the display.

The kettle must be in cooking position in order for the water in the jacket to drain. It is therefore necessary to return the kettle to upright position after any tilting.

The emptying time depends on the kettle size.



 The function can be stopped by pressing .

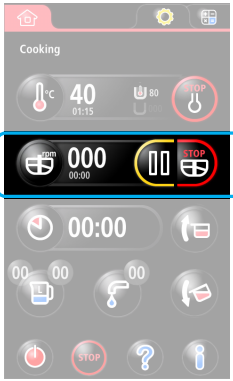

 **NOTE! Pressing  stops all kettle functions.**

4.2.3. Mixer functions



Starting the mixer (manual use)

 The mixer can only be switched on when the kettle is in upright position (cooking position). If the mixer function is selected when the kettle is not in upright position, the message "Kettle not in cooking position" appears on the display .

-  Press the mixer button.
- Start the mixer by pressing  or by touching the power control bar.

Changing the speed

- Adjust speed using the "+" or "-" buttons or by sliding your finger along the rpm slider. The speed control is equipped with a safety delay. (speed increases slowly, the finger must be kept in place until the desired speed is reached).

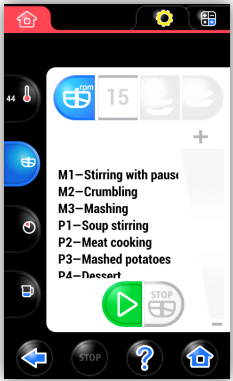

Auto-reverse function

- When the mixer is running, press  , the button will turn blue  and the mixer is auto-reversing until the button is pressed again.



Power mixing during mixing

- When the mixer is running, press .

Power mixing is heavy auto-reverse mixing, which continues as long as the button is pressed. Power mixing can be used whenever the mixer is running, also during the pre-set mixing cycles.

 Make sure before using power mixing that possible splashes of food do not cause any danger to safety at work.

Preset mixing cycles

- Select one of the mixing cycles shown.
- Start the mixer by pressing .
- Pause the mixing cycle by pressing .
- Stop the mixing cycle by pressing .



Information about mixing cycles, speeds and directions of rotation by pressing .

 **NOTE!** Pressing  stops all kettle functions.

4.2.4. Tilting the kettle

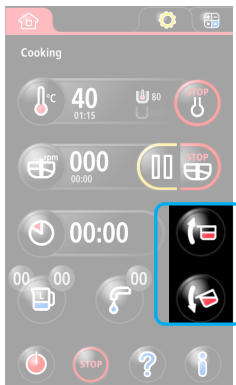

In the case of electrically heated kettles, after switching off the heating, you should wait about 5 seconds before tilting the kettle. Immediate tilting will shorten the life of the heating elements.

It is not possible to tilt the kettle when the lid is closed. In case you try to tilt the kettle with the lid closed, a message appears that the operation could not be performed.



Tilting the CulinoPro kettle is carried out by pressing the tilting button.

The kettle tilts as long as the button is held down. In case the “pull-back” function is on, (see section “5.2.3. Parameters” on page 30), a slight reversing movement occurs after the button is released, which decreases dripping of food from the the spout.

To make it possible to empty the kettle completely the reversing movement does not occur when the kettle is tilted to the extreme position.







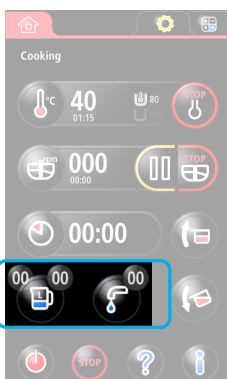

Returning the kettle to the cooking position is carried out by pressing the upright position button.

For safety reasons (safety regulations), the reversing movement lasts only as long as the button is pressed. The upright position button must be pressed until the reversing movement stops and the kettle is in the cooking position. In case the kettle is not reversed up to the cooking position, a message “Kettle not in cooking position” appears on the display when you try to switch the heating or mixing on.

4.2.5. Water filling



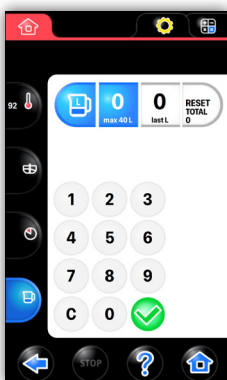

Automatic water filling

- Press .
- Set the desired amount (liters) with the keypad.
- Start the water filling by pressing .
- The display shows the set amount (liters)  and the achieved amount (liters) .
- When the set amount is reached the filling stops automatically.
- On the water filling page the last filled amount is displayed  as well as the total amount  (can be reset).





Interrupting the automatic water filling.

- Interrupt the function by pressing , the button is visible only during automatic water filling.

The filling can be continued as long as the filled amount () is shown on the display. After this the amount resets and must be set again.

Manual water filling.



- Start the water filling by pressing . The display shows the achieved amount (liters) .
- Press  when the desired water amount is achieved. The button is visible only during manual water filling.



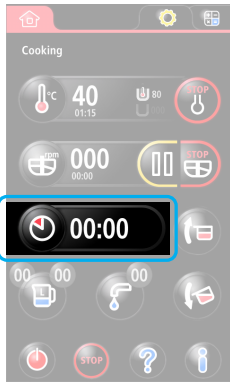

The default setting for the water filling accuracy is full liters. It can however, by setting the parameters, be set to deciliters for amounts smaller than 10 liters. The setting is done by authorized service personnel.

4.2.6. Timer ("egg timer")



- Press .
- Add new timer by pressing .
- Set the time with the keypad.
- Start the timer by pressing .

When the set time has elapsed, a message "Timer expired!" appears on the screen,

Mute the possible audio signal by pressing  or confirm by pressing . The message disappears after a while if the display is not touched.

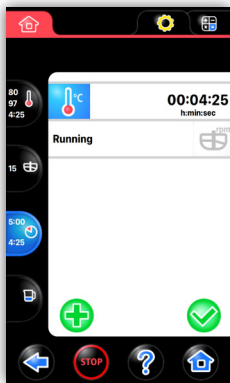

The active function, e.g. heating is shown on the timer display.

- Example: **Running** 

The function can be added to the timer by keeping the symbol pressed until it gets bigger and gets a blue background. It can then be dragged onto the timer. In this way the function stops when the set time has elapsed.

- Example:  **00:10:45**
h:min:sec



It is also possible to start several timers at the same time. Add a new timer as described above. Various timer functions can be controlled as above by holding a function symbol pressed until it gets bigger and gets a blue background wherein it can be dragged onto the timer.

Example:

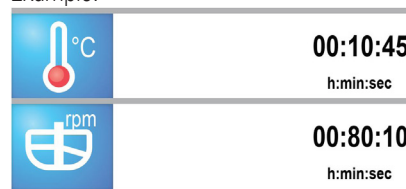

Several functions can be placed in the same timer wherein all these functions ends when the set time has expired.

Example:



A running timer can be deleted by pressing the timer field (left of the time) and keeping pressed until the

timer gets smaller and floating. The timer can now be deleted by dragging it to the waste bin  that appears at the bottom of the page. A heating function can be deleted from a timer in the same way. Keep the function icon pressed until it gets bigger and drag it to "Running".

4.3. After use

4.3.1. Cleaning



Use of a pressure washer is forbidden. Pressure washers generate huge amounts of water fog that might contribute to contamination of food and food handling surfaces over large areas in the kitchen.



Switch off the appliance with the (I/O) switch or the mains switch before starting to wash the kettle.

Cleaning of cold production kettles needs to be done with boiling water daily.



Tools not allowed for cleaning:

- pressure washer
- all metallic tools
- rough rubbing sponges
- steel wool
- abrasive detergents



Tools recommended for cleaning:

- special detergents for stainless steel
- nylon brush
- soft rubbing sponges
- other materials intended for stainless steel that do not scratch the surface



All accessories, such as strainer plates and its parts, mixing tools and scrapers and parts of the safety lid can be washed in a dishwasher suitable for washing such items.

The less the kettle surface gets scratched, the easier it is to clean. The fastest and easiest method is to clean the kettle every time right after use. Clean the pillars of the appliance by wiping.



Do not spray water on the control panel.



Cleaning the touch screen (display) and the panel overlay with steam is prohibited!



Do not cover the control panel with a plastic bag. It may build up moisture inside the panel and cause damage.



Wash the exterior of the appliance with running water only if necessary. Wiping with a damp cloth will often suffice. Consider the requirements of food hygiene when cleaning the kettle. Abundant use of water for soaking increases water consumption. However, if you want to clean the kettle by soaking, make use of the mixer and the optional washing tool to make soaking more efficient, mixing slowly during soaking.

Cleaning procedures:

- Scrape loose dirt with a plastic scraper.
- Spray detergent into the kettle, then brush and spray the kettle with water until clean.
- Dry the kettle.

The dosing and impact time instructions for cleaning detergents must be followed - e.g. exceeding the impact time for foam cleaning detergents in combination with salt residues has been observed to cause severe spot corrosion even on stainless steel.



The manufacturer does not take any responsibility for possible damage caused by not following the instructions.

Detaching the lid parts



- Make sure the kettle is in an upright position.
- Place the lid on the kettle.
- Remove the cover of the safety grid and detach the safety grid.
- Detach the solid lid from the lifting arm by holding the lifting arm with one hand and pulling the locking lever of the lid and then lifting the arm.

Refitting the lid parts

Place the solid lid on the kettle approximately in the correct position.

Pull the lifting arm down over the lid. Turn the solid lid so that the guiding pin lines up with the hole in the lifting arm center piece.

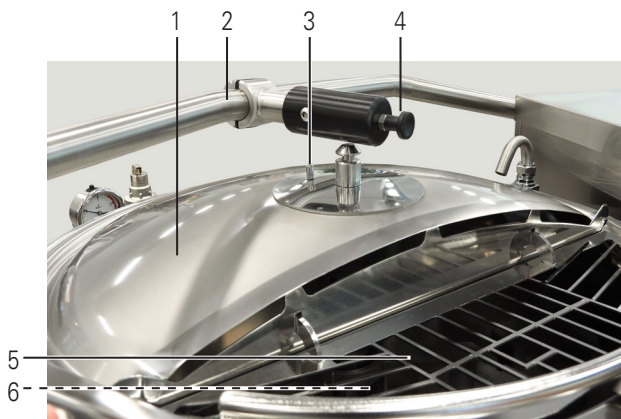

1. Solid lid
2. Lifting arm
3. Guiding pin
4. Locking lever of the lid
5. Safety grid for lid opening
6. Cover for fill opening (not shown in picture)

Press the lid arm against the lid so that the fixing cone is guided into the fixing part and the locking lever snaps in the locked position. Make sure that the lid is locked on the arm.



Put the safety grid and its cover in place.





4.3.2. Periodic service

Like a car, a food preparation appliance should be kept in good working order with the help of preventive maintenance. This guarantees trouble-free and safe operation of the appliance. Depending on how much the kettle is used and in what kind of conditions it is operated, the technical condition of the CulinoPro combi-kettle should be checked according to plan from time to time. For example, the amount of scale built up on the steam system depends on the use of the kettle and the hardness of local water. Contact your authorized service provider for recommendations on preventative maintenance to be performed.

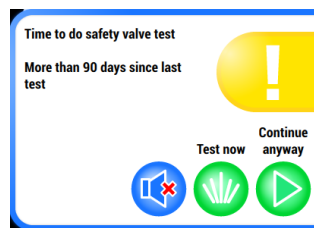
4.3.3. Safety valve test

The kettle notifies when it is time to perform safety valve test.



- Open the safety valve test page by pressing .
 - Continue without performing the test  (not recommended).
 - Mute the possible audio signal by pressing .
- Start the test by pressing . The kettle heats up.
- When the kettle is warm  is shown. Hold the button pressed until the safety valve opens.



It is not allowed to stand behind the kettle during the safety block check, because, when the check is completed, the safety valve at the kettle's rear edge opens, blowing hot steam out of the kettle. The kettle must be clean and empty. The test causes a momentary strong hissing sound. Wear hearing protection.



The kettle gives an alarm signal and interrupts the test if the safety valve does not open within acceptable limits. In this case, it is strictly prohibited to continue using at the kettle, and you should immediately contact your authorized service provider to fix the error.

4.4. Troubleshooting

The display is not lit

- The kettle is in stand-by mode. Touch the display.
- The emergency/stop button is pushed. Release the emergency-stop switch by turning it clockwise.
- The mains switch is in the "0" position. Turn it to "1" position.

The kettle informs that there is a problem with the water supply

- Check the water supply and open and open possible cutoff valve.

The kettle does not heat up

- The kettle is not in upright (cooking) position. Return the kettle to upright position.
- The draining of the jacket water is in progress. Wait until draining the delay has elapsed and then try again.
- The jacket is not empty after a cooling on a kettle with pneumatic draining of the jacket. Check the compressed air supply and open possible cutoff valve.

The mixer does not start

- The kettle is not in upright (cooking) position. Return the kettle to upright position.
- The lid is open. Close the lid.
- The safety grid is not in correct position. Check the safety lid.

The cooling does not work

- The kettle is not in upright (cooking) position. Return the kettle to upright position.
- Jacket filling problems. Check the water supply (tap water cooling).

Resetting the unit

- Turn the main power switch to position 0 and wait for about 1 minute. Turn the main power switch to 1 position.

4.4.1. Maintenance information

Keep a record of all service and repair measures carried out for the CulinoPro combi-kettle during its life cycle. Service history may speed up future service measures, help in controlling the costs and in planning new investments. The safety valve must be periodically checked as instructed in this manual. Enter the check data in the "Maintenance information" table.

Maintenance information

Combi-kettle _____ Serial No. _____ Taken into use (date) _____

Checking the safety valve four times per year:

Date	Checked by	Notes	Date	Checked by	Notes

Yearly maintenance:

Date	Checked by	Notes	Date	Checked by	Notes

Descaling:

Date	Checked by	Notes	Date	Checked by	Notes

5. Adjustment instructions

5.1. Changing the settings without logging



The following settings can be altered without logging:

- Fresh water function
- Memory functions (Only HACCP to USB without logging in.)
- Language
- Time and date
- Sounds (only the volume can be set without logging)
- Safety valve test
- Version info
- Use of electricity and water

Scroll through the options by scrolling the page with your finger.



Confirm the selected option by pressing .

Cancel the selection by pressing .



5.1.1. Fresh water function

Fresh water function rinses the water pipes when the kettle has not been used for a certain time. The function rinses stagnant water and any deposits from the pipes. The Fresh Water Function page shows when the function was performed the last time.



Set the duration of the fresh water function (0 ... 600 s)

- Press the current setting.
- Set a new value with the key pad.
- Save the changes by pressing .
- Return without saving by pressing .

Set the function interval (0 ... 24)



- Press the current setting.
- Set a new value with the key pad.
- Save the changes by pressing .
- Return without saving by pressing .

Manual operation of the function

- Start / stop the function manually by pressing  and .
- Return without performing the function by pressing .

5.1.2. Memory functions



This function allows the HACCP log file to be stored on a USB memory stick.

- Connect the USB stick to the USB port and press .
- Return without performing the function by pressing .

5.1.3. Teach mode

This function sets the kettle in a fully simulated mode. It means that the kettle doesn't react to any sensors and doesn't control any real functions.

You can practice how to use the kettle without the kettle doing anything. For example, you can test how heating or mixing works without the kettle heating or mixing.

The teach mode is indicated on screen as a teacher symbol  in the settings tab. The settings tab has a cog symbol  when teach mode is off.

5.1.4. Language

The language page shows the available language choices.

- Select the desired language by pressing the language bar.
- Return without performing the function by pressing .



5.1.5. Time and date

Set the time and date:

- Set the time and date by pressing the fields and setting the corresponding values with the keypad.
- Save the changes by pressing .
- Return without saving by pressing .



5.1.6. Sounds

This feature allows you to adjust the volume. Other sound settings require a login.

- Adjust the volume by sliding your finger across the volume bar .
- Return without performing the function by pressing .

5.1.7. Safety valve test

With this function the safety valve test can be performed.

- Perform the safety valve test by pressing .
- Return without performing the function by pressing .

5.1.8. Version info

This functions shows information that a service technician might ask for when a service call is made.

5.1.9. Use of electricity and water

This function allows you to check the electricity (electrically heated kettle) and water use. The function does not measure the water used with the hand-held shower.

5.2. Changing the settings that require logging in as chef



The following settings can be modified when logged in as chef. Default log in code for chef is "1234" and it can be changed with the parameters.

- Fresh water function (see section "5.1.1. Fresh water function" on page 27).
- Memory functions
- Language (see section "5.1.4. Language" on page 28).
- Time and date (see section "5.1.5. Time and date" on page 28).
- Sounds
- Parameters
- Safety valve test (see section "5.1.7. Safety valve test" on page 28).
- Version info (see section "5.1.8. Version info" on page 28).
- Use of electricity and water (see section "5.1.9. Use of electricity and water" on page 28).

Scroll through the options by scrolling the page with your finger.



Confirm the selected option by pressing .

Cancel the selection by pressing .

5.2.1. Memory functions

With this function the following memory function can be carried out:





Save HACCP to USB

- Connect the USB stick to the USB port and press .
- Return without performing the function by pressing .

After performing the function, "HACCP logs saved to USB" appears on the display.

5.2.2. Sounds

With this function, you can select the audio signal for the different function as well as set the volume.

- Adjust the volume by sliding your finger across the volume bar .
- Select the audio signal by pressing the audio button for the desired function, if no sound is selected the button is labeled "no sound".
- Listen to the sound by pressing .
- Select the sound by pressing .
- Return without performing the function by pressing .

5.2.3. Parameters

Some of the features can be changed by parameters. You have to log in as chef to change the parameters.

Each parameter has the following features:

111: Chef login time out 15 s - 36000 s (600 s)	600 s
--	--------------

111: Parameter number.

Chef login time out: Parameter description.

15s - 36000s (600s): Minimum value - maximum value (factory setting).

600s: The parameters current value

To change a numeric parameter value, click on it.

-> set a value for the parameter with the keypad that appears on the display:

Clicking a non numeric parameter does not show a keyboard, but simply toggles the parameter to next value, like:

113: Chef login time out enabled (Yes)	Yes
113: Chef login time out enabled (Yes)	No

6. Installation

6.1. General



Please observe the instructions given in this chapter concerning the installation and adjustments that must be done before taking the CulinoPro combi-kettle into use. Strict observance of the instructions prevents malfunctions and damages potentially caused by defective installation.

Do not switch the power on if the installation place is damp or wet (building site conditions).

6.1.1. Operating conditions

The CulinoPro combi-kettle can be used in a normal, air-conditioned professional kitchen. The room temperature of the installation place must not exceed +40°C and the relative humidity must be less than 80% (condensation on surfaces not allowed to occur). If the temperature of the facility in winter conditions is below 0°C, the steam generator of the combi-kettle must be drained and the kettle must be emptied to avoid damage caused by freezing. The kettle's pipes and solenoid valve bodies must be emptied at the same time.

6.1.2. Possible interference from the surroundings (to the surroundings)

The CulinoPro combi-kettle fulfills the requirements of the EMC directive concerning the emissions and immunity to electromagnetic disturbances. In case there are electronically controlled appliances and, in particular, devices fitted with a frequency converter in the installation place, it is recommended to ensure their conformity with the relevant regulations and that their cabling has been done according to instructions.

6.1.3. Storage

The CulinoPro combi-kettle must be stored in a dry place, at a temperature between +10 and +40°C. The kettle should be kept in its transport package during storage.



If the appliance is stored in construction site conditions, special care must be taken not to damage it through other operations on the site.

- Protect the exterior of the combi-kettle from scratches and knocks.
- Protect the combi-kettle from construction site dust.
- **Protect the combi-kettle from sparks produced by welding, grinding and abrasive cutting wheels. These can later cause rust spots on the stainless steel surface of the appliance.**

6.1.4. Unpacking the appliance

The combi-kettle should be transported in its own package as close as possible to the installation place before final unpacking. Do not remove the protective film until after installation, just before the first use of the kettle.



After removing from the transport pallet, the combi-kettle is not stable until it has been bolted down to the installation frame. It is strictly forbidden to operate or tilt the kettle before it has been fixed to the floor or to the free standing frame according to the installation instructions. When the combi-kettle is removed from its transport pallet, it must be supported to prevent it from falling before it is fixed to the floor. If the kettle falls down, this may cause injury to people or damage to property.

6.1.5. Disposal of the package

After unpacking all packing material must be sorted and disposed of in accordance with local recycling regulations.

6.2. Installation

Check before installation from the installation drawing that there is enough space behind the kettle for tilting and servicing. Also check the location of the floor drain.



The CulinoPro combi-kettle is designed for installation in a place with a floor drain in front of the kettle. The arrangement with a pouring channel and floor drain behind the kettle is not suitable for use with the combi-kettle.

The combi-kettle can be installed in three different ways:

- FM (=floor-mounted): On a subsurface installation frame, the frame cast into the floor.
- FM (=floor-mounted): On a surface installation frame, the frame fixed to the floor surface.
- FS (=free-standing): Free-standing.

Installation dimensions and floor drain placement, see section "7. Technical specifications"

6.2.1. Floor-mounted kettles (FM)



For kettles size 200 - 400 l a subsurface frame installation is recommended.



Fixing the kettle directly to the floor without frames is forbidden.

Either subsurface frames or surface frames must be in position before the installation of the combi-kettle is started.

6.3. Residual current device recommendation

Electrically heated 40 - 400 liters kettles with mixer: Type A residual current device with high frequency filtering or a residual current device separately approved for use with frequency converters.

6.4. Installation frames

6.4.1. Positioning of installation frames

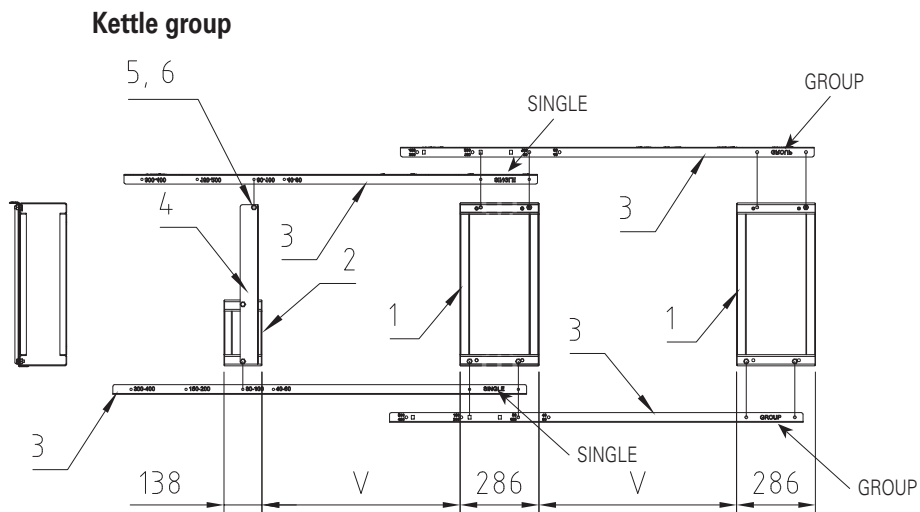
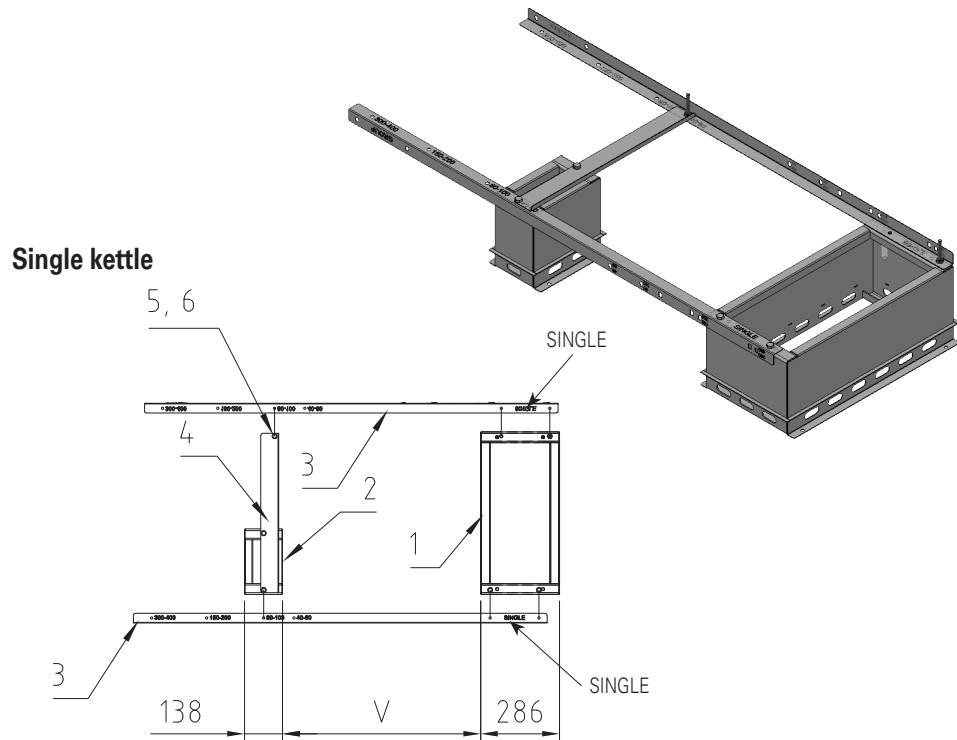

Installation frames

- MG4224000 Surface installation
- MG4224002 Sub-surface installation
- MG4224004 Group installation, surface
- MG4224006 Group installation, sub-surface

1. Control pillar frame
2. Support pillar frame
3. Installation guide : 3917669
4. Spacer guide: 3917668
5. Hex bolt M10x20
6. Hex nut M10

Model	V (mm)
40E, S	608
60E, S	608
80E, S	718
100E, S	718
150E, S	924
200E, S	924
300E, S	1124
400E, S	1124

6.4.2. Subsurface frame cast into the floor

Installation frames are mounted according to the installation drawing, with the help of installation guides supplied with the delivery. The frames must be installed in a horizontal position and fixed so that they do not move during casting.

The installation frames must be positioned so that their upper surface is 172 mm above the finished floor surface. The junction of the installation frame and floor is filled with flooring material.

After pouring the concrete floor and after the concrete has dried, remove the installation supports (see section 6.4.1 parts 3-6). The best result in terms of tightness is achieved by filling the installation frame with concrete, which is then covered with a floor coating to prevent moisture from entering the concrete.

Note: Ensure that the fixing bolts (5) and protective sleeves for fixing bolts (6) are in place and the bolts are tightened to the bottom before pouring the concrete. The main points of the casting frame are shown in the figure below.

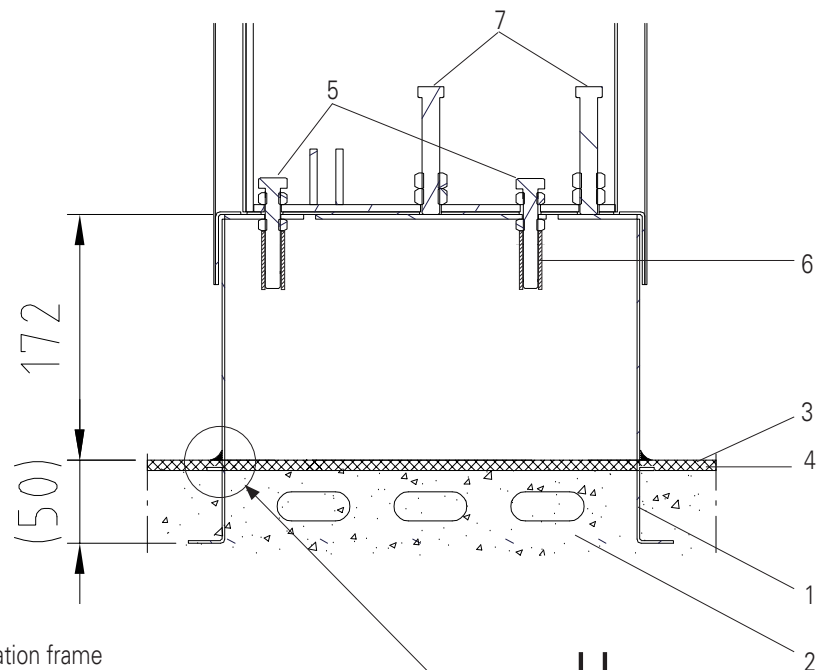

1. Installation frame
2. Concrete casting
3. Finished floor surface
4. Floor coating
5. Fixing bolt
6. Protecting sleeve for fixing bolt
7. Adjusting bolt

Place the kettle on the installation frame and adjust to a horizontal position with the adjusting bolts. When the kettle is in a horizontal position, it must be fixed to the installation frames with the help of the fixing bolts. The control pillar has 4 bolts and the support pillar has 2 bolts. Tighten the adjusting nuts carefully. Do not seal the space between the kettle pillars and installation frame as there must be enough change of air.

6.4.3. Surface installation frame fixed to the floor

Surface frames are mounted according to the installation drawing, with the help of installation guides supplied with the delivery. If the inclination of the floor is very steep, it may be necessary to level the surface frame closer to the horizontal by placing stainless steel spacers between the frame and the floor. This will ensure that the adjustment range of the pillars is adequate.



Pieces of stainless steel plate should be used as spacers that are large enough and have a suitable hole for the fixing bolt. Washers or other small spacers are not allowed.

The fixing bolts for the surface installation must be chosen according to the floor construction. A type recommended is a UKA M10x150 chemical bolt, which suits various floor materials. Alternatively expansion-shell bolts or equivalent can be used. The junction of the surface frame and the floor is filled with flooring material. The main points concerning the installation of the surface frame are shown in the picture below.

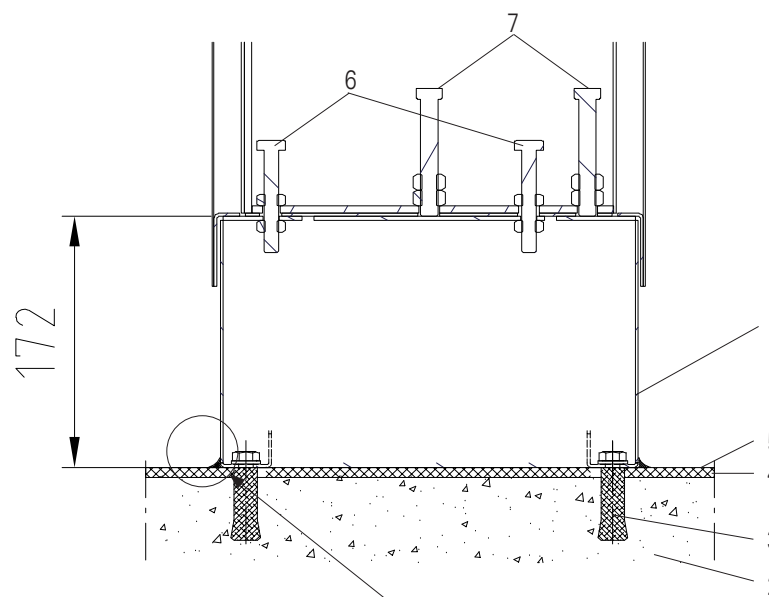

1. Surface frame
2. Concrete casting
3. Fixing bolt for surface frame
4. Finished floor surface
5. Floor coating
6. Fixing bolt
7. Adjusting bolt

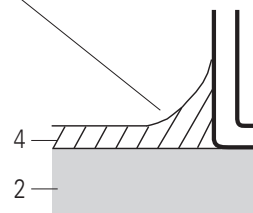

Place the kettle on the surface installation frame and adjust to a horizontal position with 4 adjusting bolts. When the kettle is in a horizontal position it must be fixed to the surface frame with the help of the fixing bolts. The control pillar has 4 bolts and the support pillar has 2 bolts. Tighten the fixing bolts carefully. Do not seal the space between the kettle pillars and surface installation frames, as there must be enough change of air.

6.5. Installation on frames

Installing the first left hand kettle or a single kettle

The kettles are delivered attached to a pallet with transport brackets.

The front and rear cover plates of the kettle's control pillar and the side plates of the support pillar must be detached before installation. Each plate has been fixed at its lower edge with two screws. After that, it is also possible to detach the lead-through plate of supply cables and water pipes located at the lower rear edge of the control panel by loosening four screws.

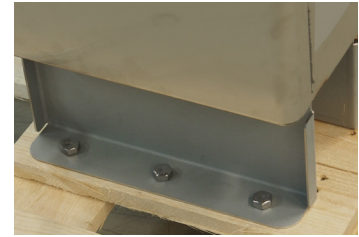

Move the kettle to the installation frame as follows:

- Cut the longitudinal boards of the pallet and push the fork-lift trolley below the kettle.



Care must be taken that the lifting arms of the fork-lift trolley do not hit the parts protruding from the kettle bottom, i.e. the mixing motor cover box (CulinoPro 40, 60, 80, 100, 150, 200) as well as the drain and discharge pipes. Lift from the edges, NOT from the bottom plate.

Furthermore, it is recommended to place e.g. plywood strips between the fork-lift trolley and the kettle bottom. It should be observed that the kettle pillars also move. It is advisable to put a piece of foamed plastic or a rolled cellular board between the kettle and the pillars so that they do not hit each other.

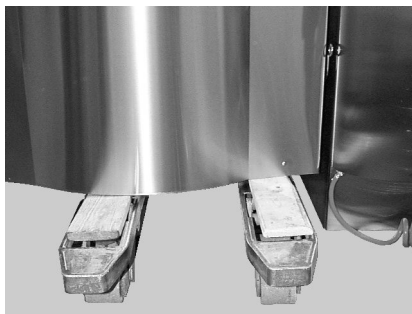

CulinoPro 40, 60, 80, 100, 150 and 200

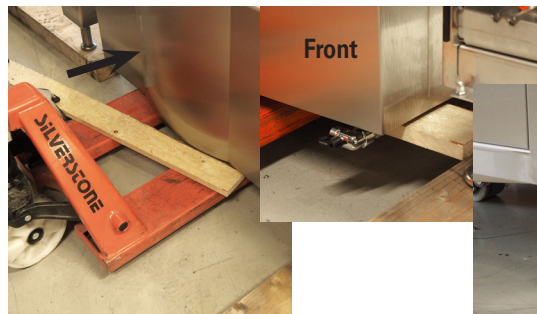

CulinoPro 300 and 400

- Lift the forklift trolley so that it supports the kettle preventing it from tipping over when the transport brackets are removed.
- Remove the kettle from the transport brackets by loosening the bolts.
- Lift the kettle off the pallet.
- Move the kettle with the forklift onto the installation frame.
- Start installing the combi-kettle or kettle group by first positioning the left-hand support pillar in place. Lift the support pillar (1) on the installation frame (2) and adjust it by means of the adjusting bolts (3) to a horizontal position and to a height of 900 mm measured from the top of the support pillar front edge to the floor. When the support pillar (1) is in place, fix it with two fixing bolts (4) to the installation frame (2).

1. Support pillar (from above)
2. Installation frame
3. Adjusting bolt
4. Fixing bolt



- Next, the control pillar (1) is adjusted by means of the adjusting bolts (3), to a horizontal position and on the same level with the support pillar. When the control pillar (1) is in position, it is fixed to the installation frame (2) with four fixing bolts (4). Check that the space between the kettle section and the support and control pillars is the same, both at the top and at the bottom.

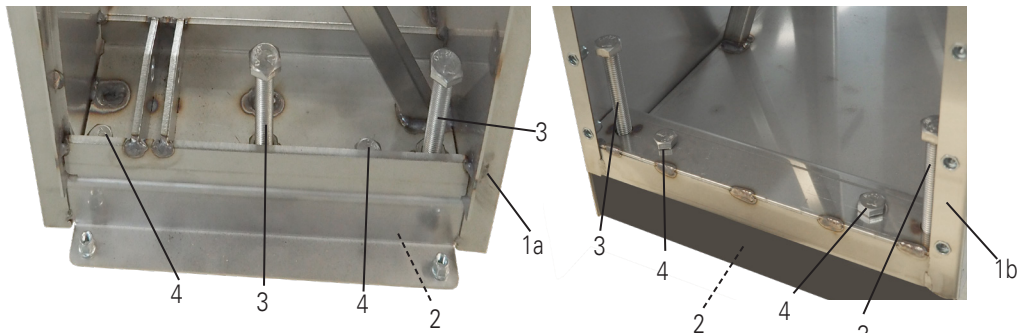

- 1a. Control pillar (front side)
- 1b. Control pillar (back side)
- 2. Installation frame
- 3. Adjusting bolt
- 4. Fixing bolt

Installing the following kettle in a kettle group

If a kettle group is installed proceed as follows:

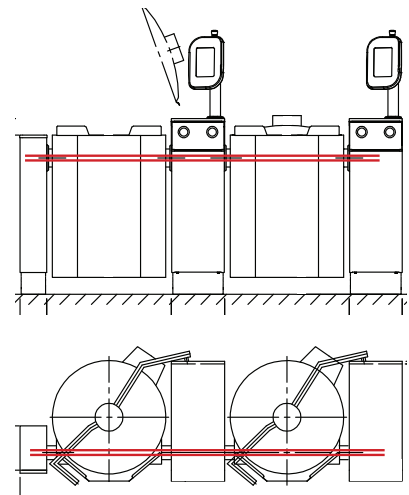
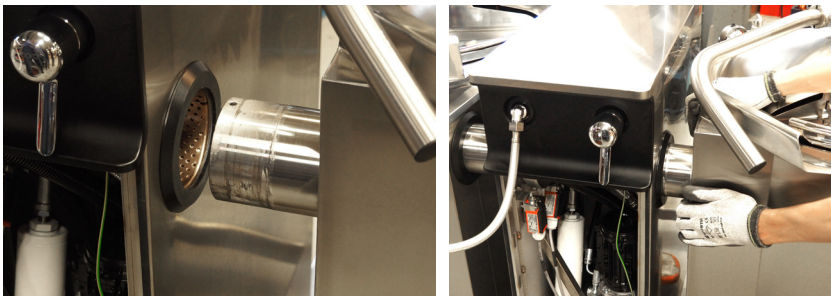

- Align the two kettles at the same height and move them together.
- Push the axle into the bearing. Apply grease if needed.



Make sure that the axles of the kettles align, both horizontally and sideways. Adjust if needed with the adjusting bolts.

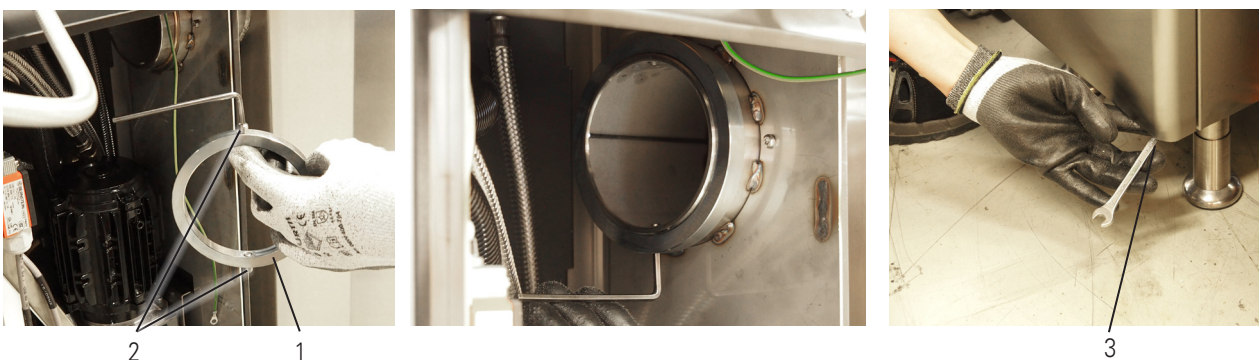

- Mount the locking ring (1) and secure it with the two locking screws (2) (4 mm Allen key). After that the cover plate of the kettles control pillar can be refitted (3) (10 mm spanner).

6.6. Free standing kettles

Installing the first left hand kettle or a single kettle

40 - 200 liter kettles

40 - 200 liter kettles can be delivered attached to a pallet with transport brackets or pre-mounted on the free standing frame.



If the kettle is pre-mounted on the free standing frame, see "300 and 400 liter kettles" on the next page.

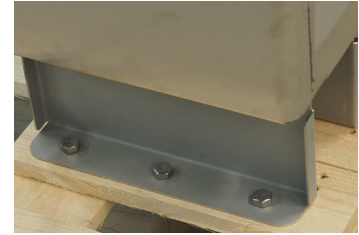

Mounting the kettle on a separately supplied free standing frame:

- Cut the longitudinal boards of the pallet and push the fork-lift trolley below the kettle.

Care must be taken that the lifting arms of the fork-lift trolley do not hit the parts protruding from the kettle bottom, i.e. the mixing motor cover box (CulinoPro 40, 60, 80, 100, 150, 200) as well as the drain and discharge pipes. Lift from the edges, NOT from the bottom plate.

Furthermore, it is recommended to place e.g. plywood strips between the fork-lift trolley and the kettle bottom. It should be observed that the kettle pillars move. It is advisable to put a piece of foamed plastic or a rolled cellular board between the kettle and control pillar so that they do not hit each other.

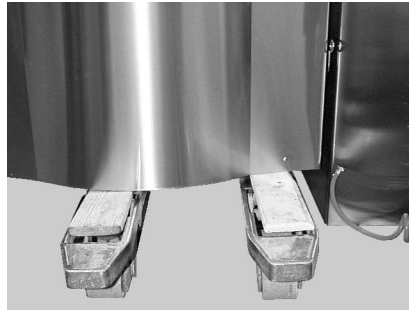

- Lift the forklift trolley so that it supports the kettle preventing it from tipping over when the transport brackets are removed.
- Remove the kettle from the transport brackets by loosening the bolts.
- Lift the kettle off the pallet.
- Move the kettle with the forklift onto the free standing frame and lower it into place.
- Attach the kettle to the free standing frame with M10 bolts.
- Check that the kettle is horizontal. Adjust if needed using the adjustable feet on the free standing frame. Check that the distance between the bottom surface of the free-standing frame and the floor, i.e. the cleaning distance, is 120 mm, with an adjustment range of -5 mm / +30 mm.

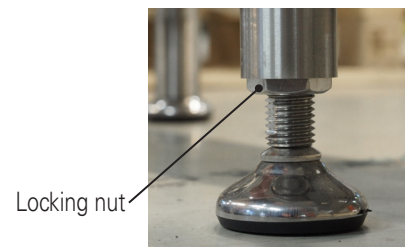
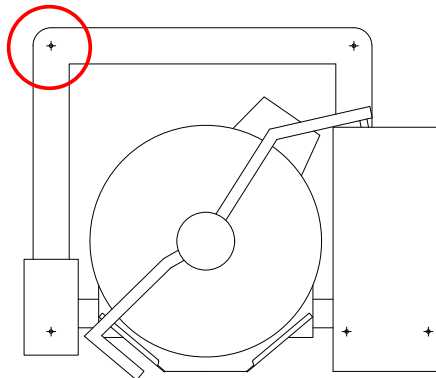

Locking nut

- Be sure to tighten the foot in the back corner of the support pillar side tight to the floor, otherwise it may lift when using the mixer with heavy loads or when tipping the kettle.
- Tighten the locking nuts of the adjustable feet after the adjustment.

300 and 400 liter kettles

The 300 and 400 liter kettles are delivered pre-mounted on the free standing frame. Also 40 - 200 liter kettles can be delivered pre-mounted on the free standing frame.

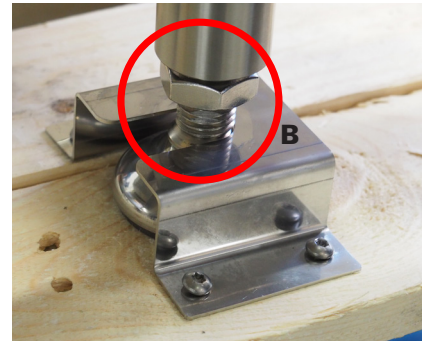
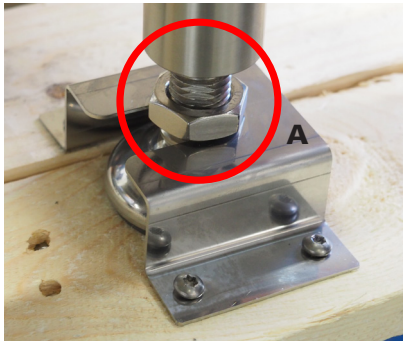
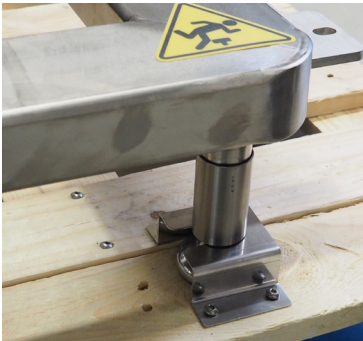

The kettle's transport base is equipped with brackets, to which the kettle is attached using the locking nuts of the leg on the frame (A).

- Remove the kettle from the bracket by loosening the locking nut (B).



Be sure to tighten the locking nuts to the top position after the kettle is set straight, see below.

- Unscrew the brackets from the transport base and lift the kettle off the transport base by cutting the longitudinal timbers of the transport base and pushing a fork-lift trolley under the kettle. Place strips of plywood or boards between the fork-lift trolley and the bottom of the kettle (see pictures below) before lifting the boiler.

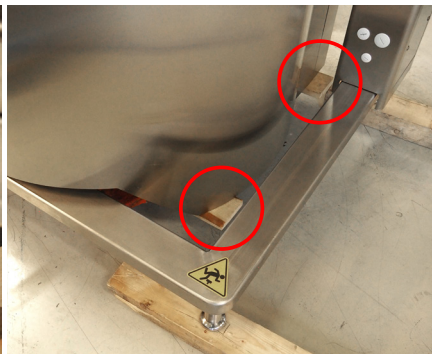

- If you are lifting the kettle from the floor, lift the kettle one side at the time and place planks under the feet of the free standing frames feet in order to lift the kettle enough to make the fork-lift trolley to fit under the kettle as described below. Put strips of plywood or planks between the fork-lift trolley and the bottom of the kettle (see pictures above) before lifting the kettle.
- Move the kettle to the installation site and check that it is horizontal.
- Adjust if needed using the adjustable feet on the free standing frame. Check that the distance between the bottom surface of the free-standing frame and the floor, i.e. the cleaning distance, is 120 mm, with an adjustment range of -5 mm / +30 mm.

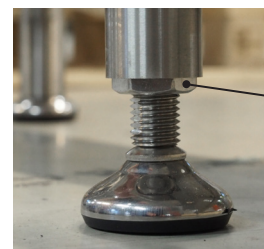
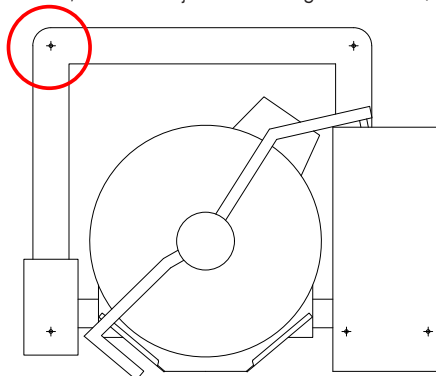

- Be sure to tighten the foot in the back corner of the support pillar side tight to the floor, otherwise it may lift when using the mixer with heavy loads or when tipping the kettle.
- Tighten the locking nuts of the adjustable feet after the adjustment.

Installing the following kettle in a kettle group

If a kettle group is installed proceed as follows:



- Remove the cover plate of the left hand kettles control pillar (10 mm spanner).

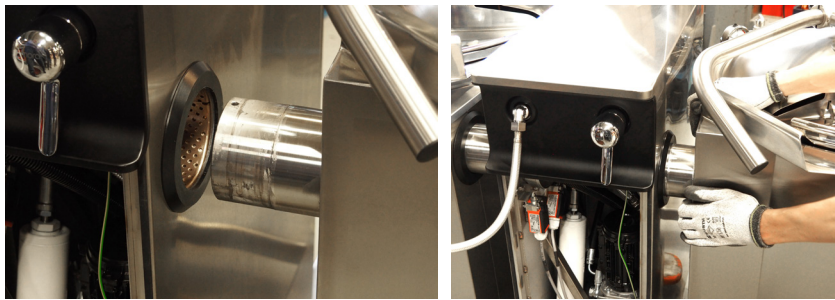

- Align the two kettles at the same height and move them together.
- Push the axle into the bearing. Apply grease if needed.

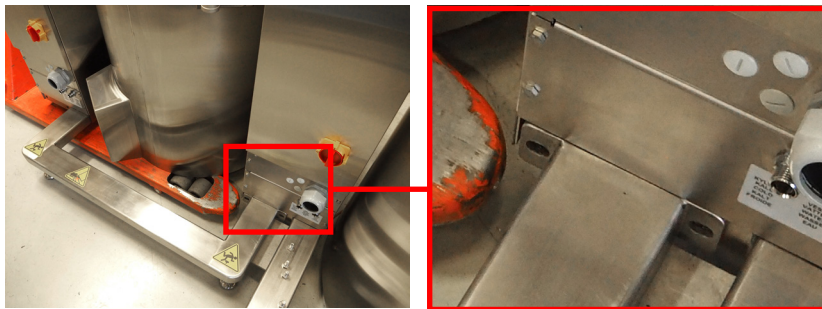

- Make sure the kettle is in position and the holes in the free standing frames of the kettles align.

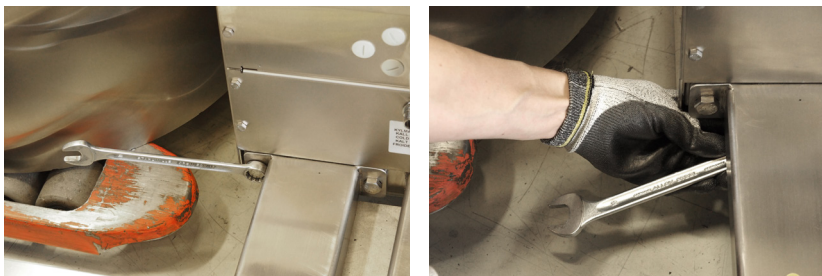

- Fix the kettles together with four 12 mm bolts using the 19 mm spanner.



- Mount the locking ring (1) and secure it with the two locking screws (2) (4 mm Allen key). After that the cover plate of the kettles control pillar can be refitted (3) (10 mm spanner).



Make sure that the axles of the kettles align, both horizontally and sideways. Adjust if needed with the adjustable feet.

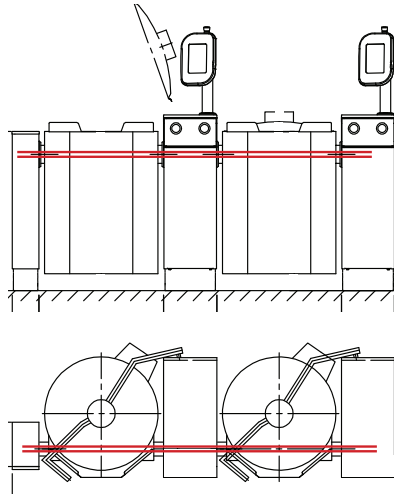

Mounting flanges

Mounting flanges (4 pcs / kettle) are recommended for all kettles and especially for large kettles (150 liters and larger) or if the floor is uneven. The flanges are glued to the floor.

- Lift one side at a time with a forklift trolley and place the flange around the legs in the corner. Lower the kettle and glue the flange to the floor.



Mounting flange

6.7. Electrical connections



The electrical connections of the CulinoPro combi-kettle can only be carried out by a qualified electrician having the necessary competence for the installation and service of electrical appliances.



The control pillar cover plate is a fixed component, not intended for detaching. Do not force it upwards when removing the front and rear cover plates.

To make the electrical connections, the upper left-hand side plate, where the mains switch is located, must be removed.

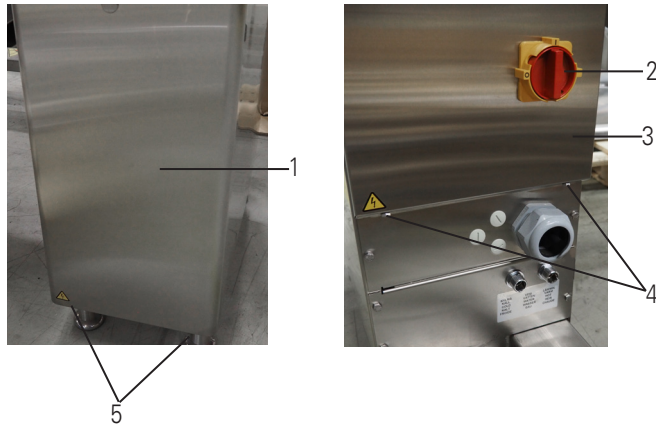



1. Front plate
2. Mains switch
3. Rear plate
4. Mounting screws for the rear cover plate of the control pillar, 2 pcs
5. Mounting screws for the front cover plate of the control pillar, 2 pcs

Turn the mains switch (2) to the OFF position.

If the control pillar front plate (1) needs to be removed, unscrew the two mounting screws (5) at the bottom of the cover plate and pull the cover plate straight down.

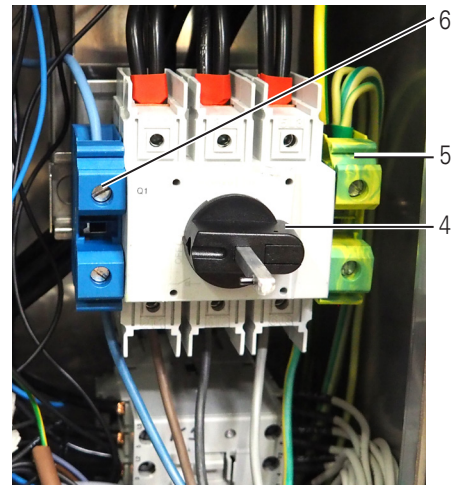
Detach the rear cover plate (3) by opening the screws (4).



1. Supply cable
2. Lead-through plate
3. Cable bushing
4. Mains switch
5. PE terminal
6. N terminal
7. Screw marked with a  symbol

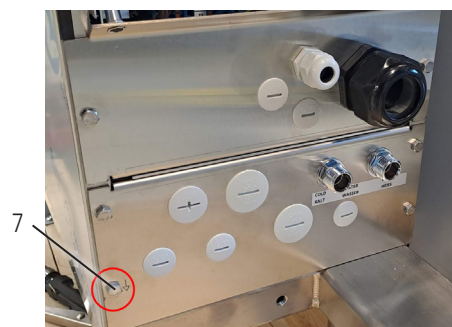

Detach the lead-through plate (2) from the pillar. Slip the supply cable (1) through the cable bushing (3) of the lead-through plate. Connect the phase wires of the cable to the mains switch (4) and PE and N cables (5, 6) to the terminal blocks.

After that, check phase order to make sure that the mixer and tilting motors rotate in the correct direction.

Close the lid and safety grid of the combi-kettle, but do not put the cover of the safety grid on.

Turn the mains switch to position 1 and switch the combi-kettle on by pressing . The display will show the basic functions.

Press  Start the mixer by pressing .

The mixer should rotate clockwise.

Stop the mixer by pressing .

On hydraulically tilted CulinoPro 200, 300 and 400 combi-kettles, you also have to check the rotation direction of the hydraulic pump motor.

Open the kettle lid and tilt the kettle by pressing .

If the motor is running but the kettle does not tilt after pressing the button for moment the rotation direction is wrong.

If the rotation direction in two foregoing points is wrong, two phases of the supply cable coming to the mains switch have to be exchanged.

Tighten the screws of the cable connections and the cable bushing properly, refit the lead through plate and the rear cover plate.

When needed, connect an external equipotential conductor under the screw (7) marked with a  symbol.

6.7.1. Electrical connection to peak power regulating systems

The CulinoPro combi-kettle is prepared for connection to peak power regulating systems like Sicotronic or Ecotronic. These systems continuously monitor all the connected appliances of the site and intelligently control electrical power usage in order to keep total peak energy under set limit and at the same time minimize the effect this has on the usage of the appliances. The connection terminals are shown in the picture below. Before making the connections the wire links between terminals X3:1-3 and X3:2-4 must be removed.

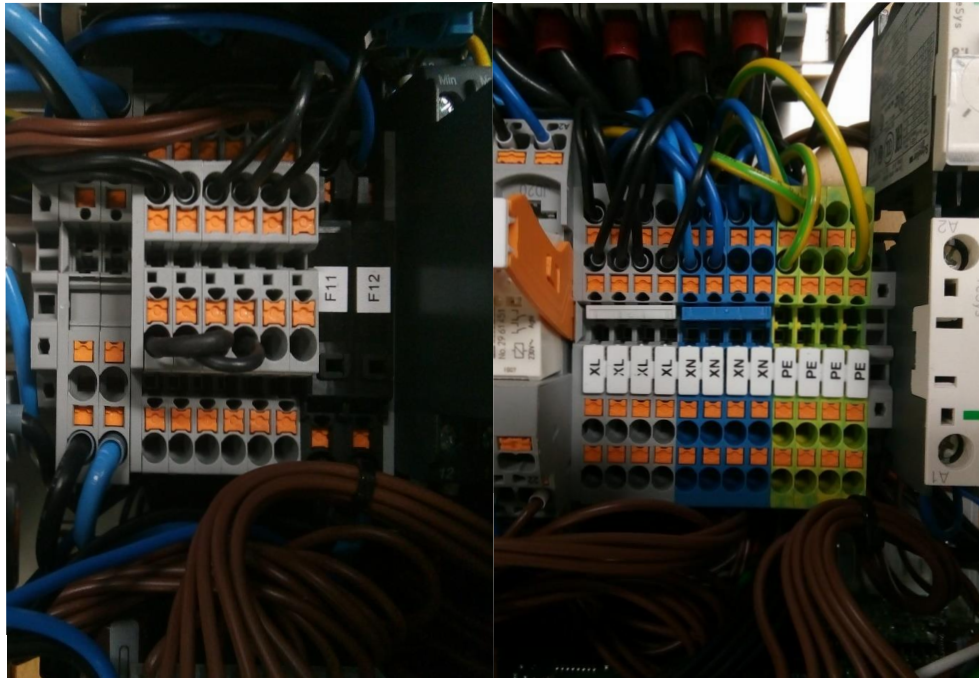

Remove wires from X3:1-4 to connect external system	
X3:1, 3	Heating contactor K2 control
X3:2, 4	Heating contactor K1 control
X3:5	Heating ON signal
XN	Neutral
PE	Protective earth

6.7.2. Forced half power

In cases where there is a limitation of electrical power supply there is a possibility to force the kettle to half heating power in order to enable some other appliance to momentarily be switched on. This will of course to some extent affect the cooking process of the kettle. The control input is to be connected to a potential free closing contact. The connection terminals are shown in the picture below.

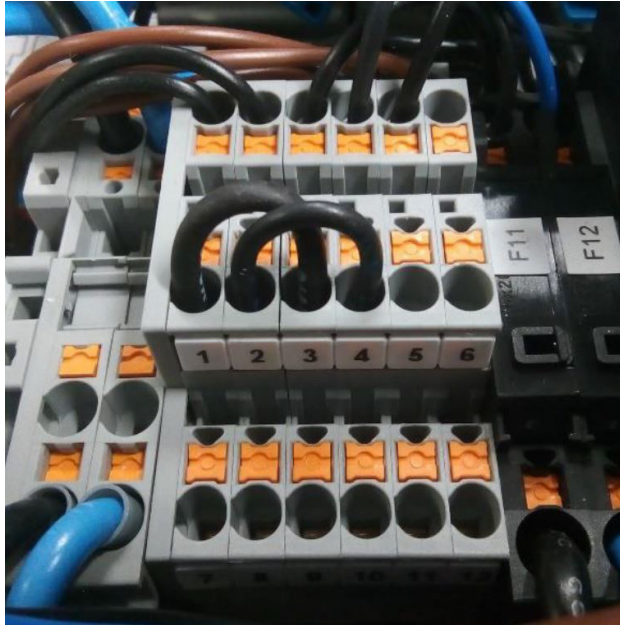

X3:11-12	Potential free forced half power input
----------	--

Electrical connections

A. Connections from the rear

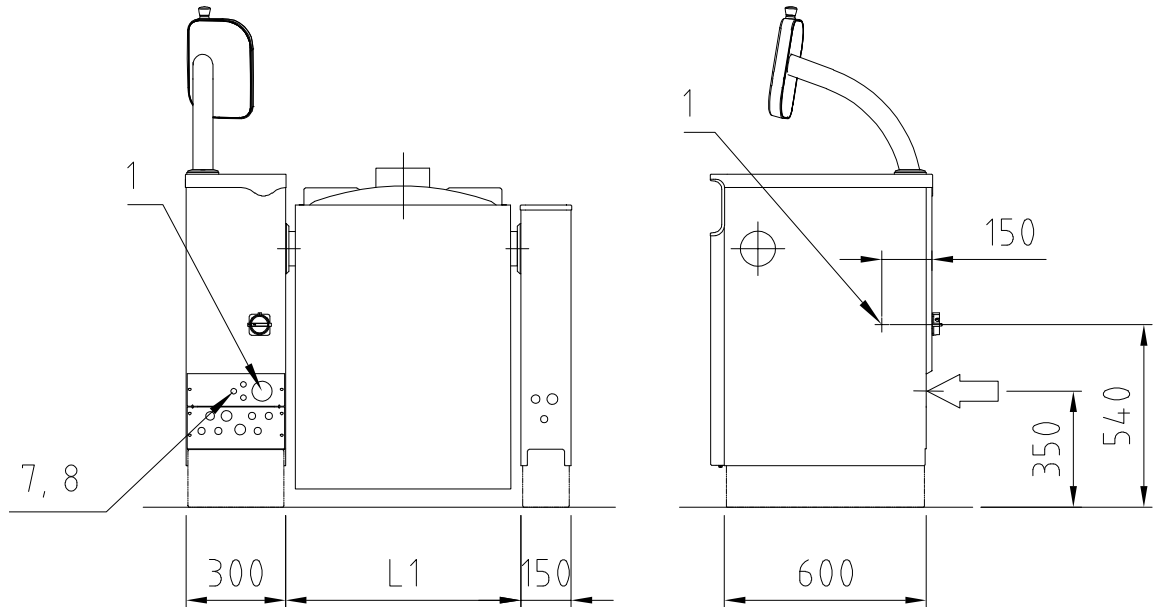

B. Connections from below

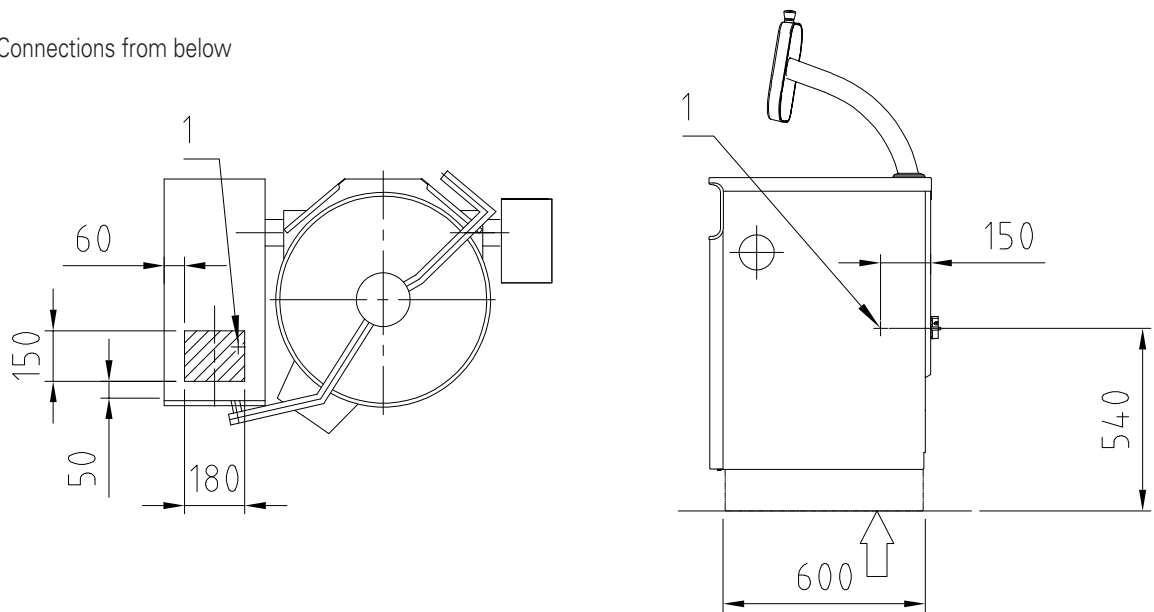

- 1. Electrical power supply cable, PG21/PG36/PG48 gland.
- 7. HACCP cabling (option).
- 8. Power management system control cable (option).

Detailed electrical connection data available in kettle electrical diagram.

6.8. Water connections



Water connections of the CulinoPro combi-kettle can only be carried out by a person with professional competence in the installation and service of heating, plumbing and air conditioning equipment.

The location of the water connection points appears from the installation drawing. Both cold and hot water connections must be fitted with a closing valve and a non-return valve (not included in delivery). The sizes of water connection points are as follows:

- Cold water: connection with R1/2" outer thread, supply with min. 15 mm inlet pipe.
- Hot water: connection with R1/2" outer thread, supply with 10 mm inlet pipe (max. +60°C).



If the cold water inlet pipe is smaller than 15 mm, water flow will decrease and the filling times will be longer than indicated.

- Cold and hot water supply lines must be fitted with a one-way valve and a shut-off valve (not included in delivery).
- Before connection to the unit all water lines must be thoroughly rinsed from all loose particles.
- The water pressure range for optimum performance is 250 - 600 kPa.
- The minimum water pressure allowed for proper function of the unit is 250 kPa.

Connections from the rear

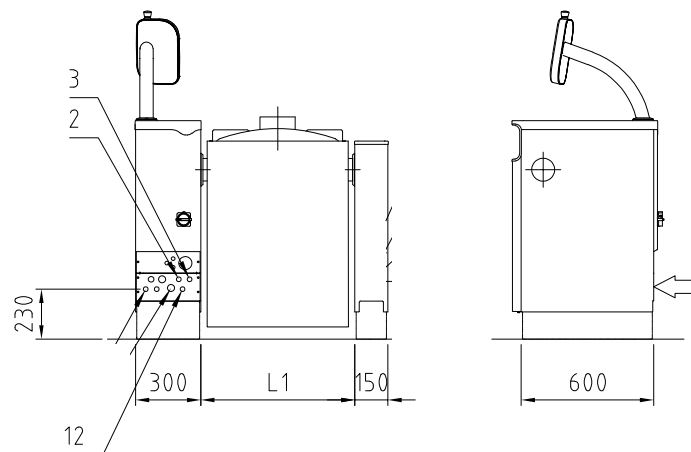

Connections from below

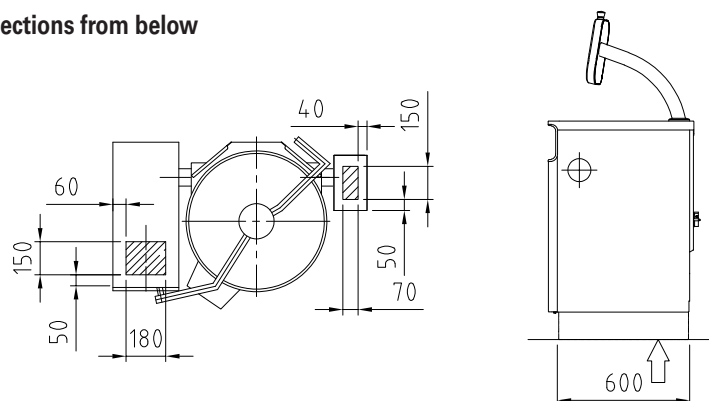

2. Cold water connection R1/2" (ø15). Must be fitted with a one way valve and shut off valve.
3. Hot water connection R1/2" (ø15). Must be fitted with a one way valve and shut off valve. (option)
12. Twin water inlet R1/2"(option)

6.8.1. Water connection and quality requirements

- The unit must be connected to the cold and hot water supply and, if fitted with a twin water connection option (T), also to the soft water supply.
- All water supply lines must be fitted with a one-way valve and a shut-off valve (not included in delivery).
- Before connection to the unit all water lines must be thoroughly rinsed from all loose particles.
- The minimum water pressure allowed for proper function of the unit is 250 kPa. If the pressure is lower, a pressure rise pump must be fitted by the customer.
- The maximum water pressure allowed for the unit is 600 kPa.
- The minimum water flow rate in the kettles is 5 l/min. To ensure optimal operation of the unit, it is recommended cold water flow rate must be at least 20 l/min.
- All water connections are of size Ø15mm (R 1/2").
- The size of particles in the water must not exceed 15 µm.
- Water conductivity should be below 1000µS/cm. Already when the conductivity is over 500µS/cm, a water analysis is recommended.
- Maximum chloride concentration allowed is 60 mg/l.
- Maximum chlorine concentration allowed is 0,2 mg/l.
- The pH value of the water should be between 6,5 and 9,5.
- The water hardness should be less than 6 ° dH. Water hardness must not exceed 9 ° dH. If the hardness of the water is between 6-9 ° dH, it increases the need for cleaning the steam generator and shortens the lifespan of heating resistors.
- Unit damages caused by chloride, chlorine or pH values exceeding the stated limits are not covered by manufacturer warranty.

6.8.2. Extreme water conditions

When extreme water conditions not fulfilling the requirements above exist, filters and water treatment devices should be installed in order to ensure proper function of the unit and avoid corrosion. When extreme water conditions are at hand, a water quality analysis must be carried out. Depending on the results of the analysis, needed filters and water treatment devices are installed by the customer. The most common filters and treatment equipment are:

1. Particle filter

A 5-15µm particle filter is recommended when water contains sand, iron particles or other suspended matters.

2. Active carbon filter

An active carbon filter must be used if the chlorine level exceeds 0,2 mg/l.

3. Reverse osmosis system

A reverse osmosis system must be used if the chloride concentration exceeds 60 mg/l. This is very crucial in order to avoid corrosion.

4. Water softener

If a high level of scale build-up is experienced, a water softener is needed. H+ Ion Exchanger or Kleen-steam are recommended systems. Sodium ion exchangers must not be used because of problems caused by high salt content. A water softener is recommended when the water hardness exceeds 6 ° dH. Water hardness must not exceed 9 ° dH.

The optional twin water connection should be used if the water quality does not meet the above requirements and a water treatment appliance is used. The twin water connection reduces the consumption of treated water because raw water can be used for cleaning purposes and for preparing the food.

NOTE!

Several water treatment equipment will lower the flow of water. If the kettle is connected to a water treatment unit, care must be taken to ensure sufficient flow after the water treatment unit. Particular attention is needed when using a twin water connection. The branching of the water must always be done before the water treatment unit.

6.9. Ventilation

The heat and steam load of the kettle must be taken into account in the kitchen's ventilation plan. A ventilation hood must be installed above the kettle, because plenty of steam is released when the kettle lid is opened. When dimensioning the ventilation hood, the space requirement for opening the lid must be taken into account (see installation drawing).

6.10. Other installations

In case the combi-kettle being installed is connected to a kitchen power management system the connection points are shown in the electric wiring diagram.

6.11. Procedures after installation

6.11.1. Adjusting the tilting

Before refitting the cover plates on the combi-kettle control panel, you have to check and, when needed, adjust the operation of tilting.

40 - 150 liter kettles

Next you have to ensure that the kettle is horizontal when it is in the cooking position. Before that make sure that the combi-kettle's control pillar has been installed horizontally. Checking is done as follows:

- First tilt the kettle at least half-way and after that press the tilting reverse button as long as the kettle stops in the cooking position.
- Check that the kettle is horizontal by the upper rim of the kettle.



If the kettle is not horizontal, the position of the mounting plate of the tilting limit switches must be adjusted as follows:

- Tilt the kettle at least half-way.
- Loosen the locking nut for adjustment (5) and the fixing nut for the limit switch plate (6) so that the limit switch plate (2) can be moved, but after moving stays in the new point.
- If the combi-kettle in its cooking position is tilted too much towards the spout, turn the limit switch plate (2) slightly downwards. In case the kettle in its cooking position is tilted too much backwards, turn the limit switch plate (2) slightly upwards.
- Tighten the locking nut (5) slightly after adjustment, press the tilting reverse button until the kettle tilting stops and check the kettle's horizontal again by the upper rim of the kettle.
- Tighten both the fixing nut (6) and the locking nut (5), if the combi-kettle is horizontal in its cooking position. Otherwise, repeat the adjustment measures.

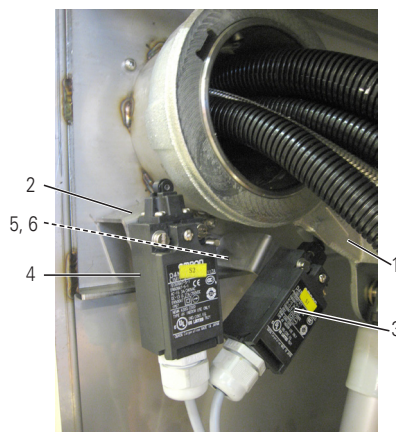

1. Tilting lever
2. Mounting plate of limit switches
3. Limit switch for cooking position
4. Limit switch of tilting end position
5. Locking nut for adjustment

200 - 400 liter kettles

On hydraulically tilted CulinoPro 200, 300 and 400 combi-kettles the rotation direction of the hydraulic pump has to be checked according to section "6.7. Electrical connections".

Next you have to ensure that the kettle is horizontal when it is in the cooking position. Before that make sure that the combi-kettle's control pillar has been installed horizontally. Checking is done as follows:

- First tilt the kettle at least half-way and after that press the tilting reverse button as long as the kettle stops in the cooking position.
- Check that the kettle is horizontal by the upper rim of the kettle.



If the kettle is not horizontal, the position of the mounting plate of the tilting limit switches must be adjusted as follows:

- Loosen the lock nut of the tilting cylinder (1).
- Loosen the limit switch of the cooking position (4).



To lighten the adjustment, tilt the kettle slightly and place a block of wood under the rear edge of the outside of the kettle and return the kettle to the cooking position so that the block supports the back of the kettle.

- Adjust the tilting by turning the adjusting nut (2).
- Tilt the kettle, remove the wood block and return the kettle to the cooking position.
- Check that the kettle is in horizontal position.
- Repeat the adjustment if necessary.
- Finally tighten the lock nut (1), adjust the cooking position limit switch (4) and adjust the limit switch of tilting end position (3) if necessary.

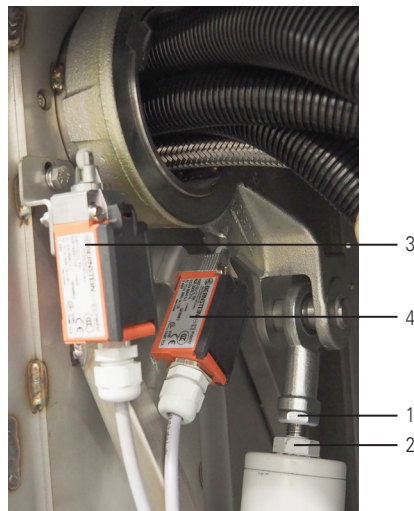



1. Adjustment lock nut
2. Tilting adjustment nut
3. Limit switch of tilting end position
4. Limit switch for cooking position

6.11.2. Fastening the mixer motor cover box

On the large kettle models (CulinoPro 150, 200, 300, 400), the cover box of the mixing motor comes unattached inside the kettle. The cover box is fastened after installation by using the screws supplied while the kettle is in a tilted position.

6.11.3. Adjusting the safety lid

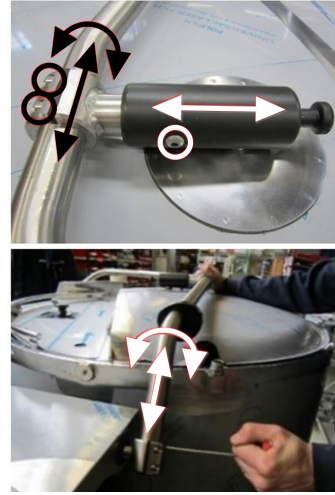
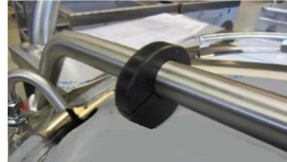
Step	Action	Note
1.	Once the kettle is installed in its final position, lock the lifting arm in place with the locking pin at the end of the lid hinge.	
2.	Check that the lines on the two stickers attached to different sides of the safety lid are aligned (see adjacent image). If the lines do not meet, the lid must be adjusted so that the lines meet.	
3.	Check that the lifting arm hinge is horizontal. Check that the straight part of the lifting arm where the cover hinge is attached is horizontal.	
4.	The position of the lid can be adjusted: 1. by adjusting the position of the adjusting sleeve by loosening and tightening the adjusting sleeve hex screw 2. by adjusting the position of the lid hinge by loosening and tightening the fixing screws (4 pcs.) 3. by adjusting the position of the lifting arm by loosening and tightening the clamping collar fastening screws at the end of the lifting arm (4 pcs.)	
5.	Once the lid has been adjusted, remove the safety lid from the kettle. Remove the protective plastic and stickers from the cover. Put the lid in place on the kettle and secure the lifting arm with the lid's locking pin.	
6.	300 – 400 liter kettles Remove the lift arm from the cover and lift the lift arm up and loosen the screw in the adjustment sleeve. Attach the lifting arm to the cover. Place the lifting arm adjustment sleeve in place as shown in the picture so that there is a gap of approx. 5-10 mm between the cover and the adjustment sleeve. Remove the lift arm from the cover and lift the lift arm up. Tighten the screw in the adjustment sleeve. Attach the lifting arm to the cover and check that there is a gap of approx. 5-10 mm between the cover and the adjustment sleeve.	

6.12. First run and testing



The following checks must be performed after the installation before taking the CulinoPro combi-kettle into regular use.

6.12.1. Filling the steam generator

The steam generator of the CulinoPro combi-kettle is empty of water on delivery. When the combi-kettle is started for the first time after installation, the steam generator is automatically filled. After first run, the combi-kettle automatically checks and maintains the correct water amount in the steam generator.

- First check that the closing valves coming to the kettle are in the ON position and the kettle's mains switch is in position 1.
- Switch the kettle on with the 0/1 button.
- The drain valve at the bottom of the kettle must be closed.
- Check that the kettle section is in the cooking position by pressing the tilting reverse button.
- Filling the steam generator of the combi-kettle can take several minutes, depending on the kettle size.

6.12.2. Safety valve test

- Press  and select "Safety valve test"
- Start the test by pressing . The kettle starts heating up.
- When the kettle is warm  is shown. Hold the button pressed until the safety valve opens.



It is not allowed to stand behind the kettle during the safety block check, because, when the check is completed, the safety valve at the kettle's rear edge opens, blowing hot steam out of the kettle. The kettle must be clean and empty. The test causes a momentary strong hissing sound. Wear hearing protection.



The kettle gives an alarm signal and interrupts the test if the safety valve does not open within acceptable limits. In this case, it is strictly prohibited to continue using at the kettle, and you should immediately contact a qualified Metos service to fix the error.

6.12.3. Earth leakage circuit breaker test (option)

If the kettle is equipped with the optional socket in the back of the control panel the earth leakage circuit breaker have to be tested after the installation by pressing the test button.

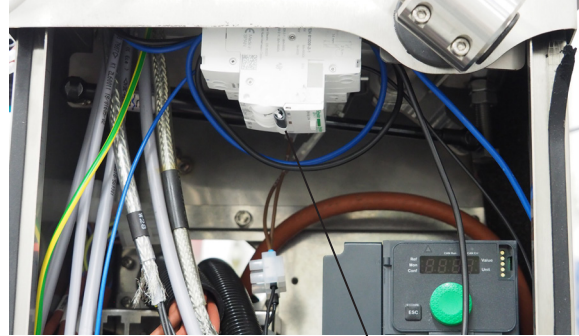

Earth leakage circuit breaker test button

6.13. Adjustments, programming

The CulinoPro combi-kettle has been programmed in the factory with values suitable for the needs of professional kitchens. The combi-kettle is, however, provided with customer specific function parameters, which makes it possible to alter certain functions to better suit the specific needs of an individual customer or kitchen.

Should adjustments be needed, see section "5. Adjustment instructions" for customer specific setting values.

Parameter values for adjustment by authorized service personnel are given in a separate service manual.

6.14. Staff training

Before taking the CulinoPro combi-kettle into use, make sure that the operators have sufficient information about the correct and safe use of the kettle.

7. Technical specifications

7.1. Dimensions

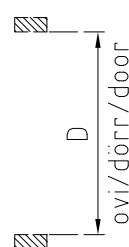
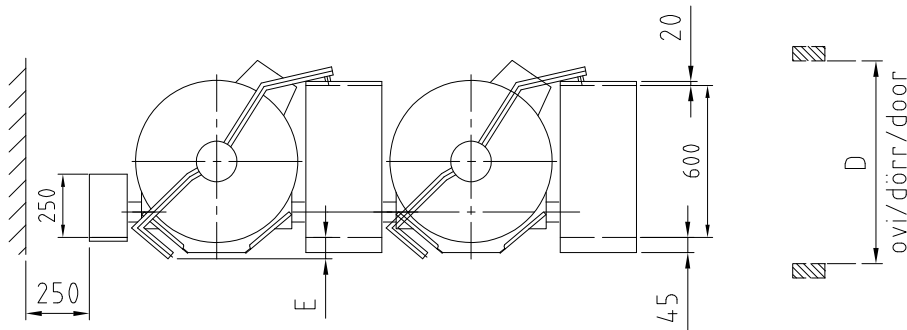
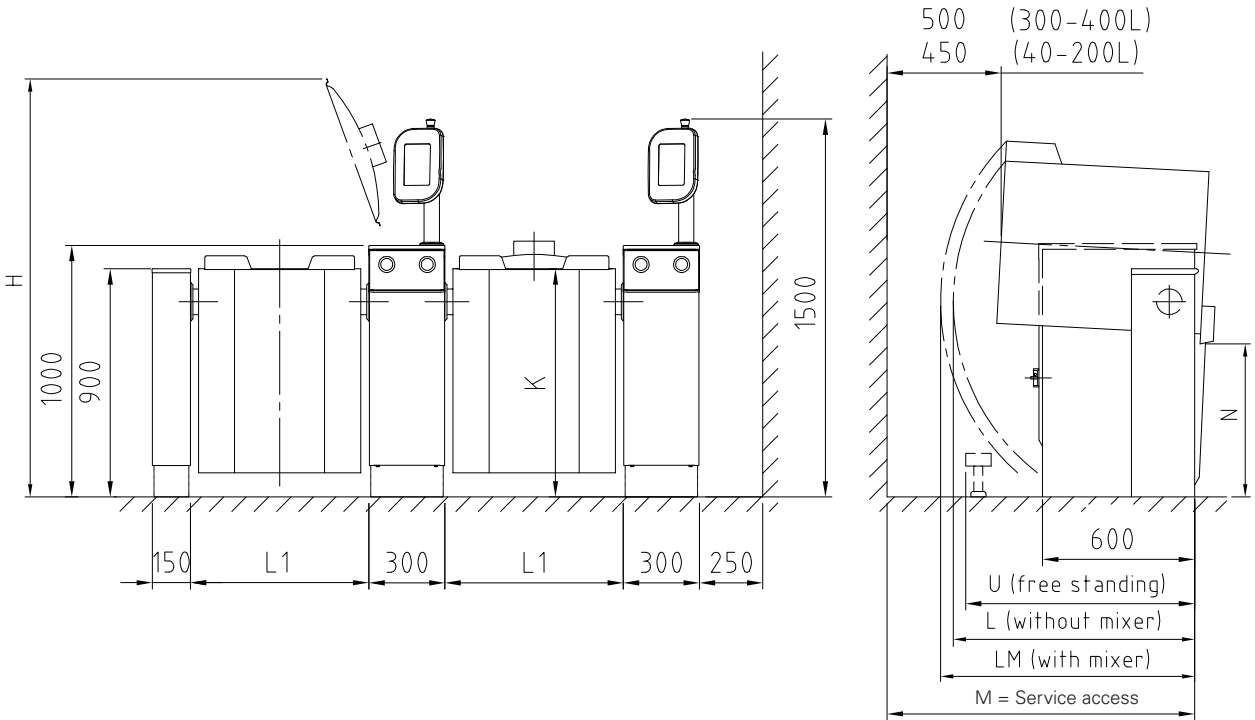

	L1	H	K	L	LM	M	M1	E	D (FM)	D (FS)	N	V	S	T	U	KG	KG	KG
40E	594	1740	900	660	925	1055	1049	100	800	1000	600	608	800	400	860	155	195	200
60E	594	1740	900	755	1010	1180	1174	100	800	1000	600	608	800	400	860	165	205	210
80E	704	1745	900	860	1055	1235	1229	85	800	1000	600	718	800	500	890	185	225	230
100E	704	1745	900	860	1055	1235	1229	85	800	1000	600	718	800	500	890	210	260	265
150E	910	1945	900	960	1115	1170	1164	110	1000	1250	600	924	800	600	1110	250	300	305
200E	910	1945	900	1035	1195	1285	1279	110	1000	1250	600	924	800	600	1110	290	340	345
300E	1110	2110	900	1280	1280	1320	1314	150	1200	1200	600	1124	1000	600	1010	350	410	415
400E	1110	2080	1050	1280	1280	1320	1314	150	1200	1200	600	1124	1200	600	1010	410	470	475

The minimum free distance to any structure behind the kettle needed for tilting of the kettle is dimension L depending on model. However service access to the components under the kettle bowl requires the bigger dimension M.

National and local regulations must be observed when installing the combi kettle.

7.2. Floor drain and installation frame positioning

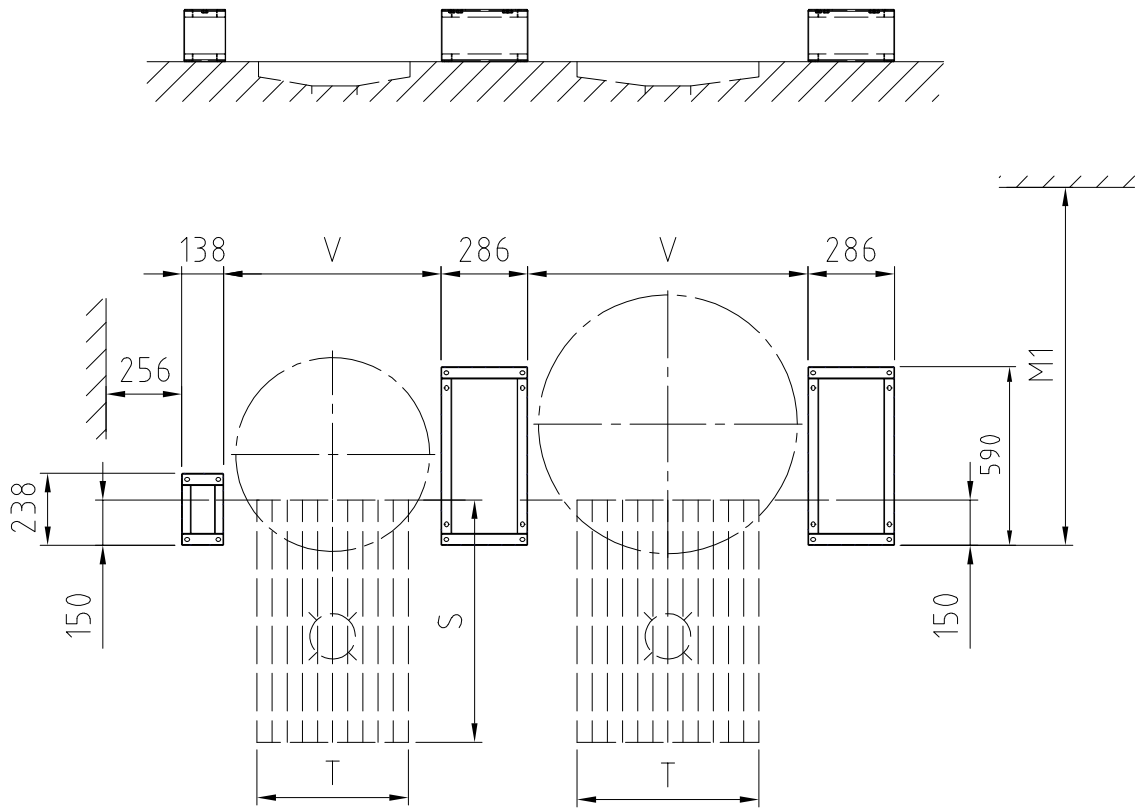

	M1	V	S	T
40E	1049	608	800	400
60E	1174	608	800	400
80E	1229	718	800	500
100E	1229	718	800	500
150E	1164	924	800	600
200E	1279	924	800	600
300E	1314	1124	1000	600
400E	1314	1124	1200	600

7.3. Water connection

Cold water connection R1/2" (ø15). Must be fitted with a one way valve and shut off valve.
 Hot water connection R1/2" (ø15). Must be fitted with a one way valve and shut off valve. (option).

7.4. Electrical connections

Electrically heated kettles

3NPE 400V 50Hz					
Type CulinoPro	Power/kW	Current/A	Fuse/A	Supply cable diameter	
				min. / mm	max. / mm
40E	12.5	24	25	22	32
60E	18.0	32	32	22	32
80E	22.0	38	40	22	32
100E	22.0	38	40	22	32
150E	27.6	50	50	22	32
150EH	35.6	62	63	22	32
200E	35.6	62	63	22	32
200EH	46.5	72	80	34	44
300E	47.6	79	80	34	44
300EH	60.8	91	100	34	44
400E	62.0	97	100	34	44

The values of the special voltages differ from the standard voltage value

8. Spare parts not covered by warranty

Wearing parts are not covered by the warranty. Wearing parts include:

- Scrapers of the mixing tool
- Brush part of the washing tool
- DiagoMix lid seal
- Other similar parts

metos		Document type Review	Document ID DOC000650	Revision A	Page(s) 1(4)
Owner organization Metos Manufacturing		Created by	Date 2019-08-19	Status Ready	
Country FI	Department	Document title Installation/commissioning checklist for Metos kettles	Approved by	Security level Confidential	

PRINTED PAPER COPY IS UNCONTROLLED - PAPERITULOSTE ON VALVOMATON KOPIO

Installation/commissioning checklist for Metos kettles

To validate warranty enclosed checklist is to be completed and returned within 14 days from installation/commissioning. This document is to be completed individually for each Metos kettle installation. Please send a copy or photos of this document (DOC000650, 4 pages) to email address: commissioning@metos.com

Customer information: *) Mandatory to fill in.

*Name:	
*Company:	
*Street:	
*ZIP code:	
*Country:	
Phone no.:	
*Email:	

*Kettle type:	
*Kettle serial no.:	
*Kettle options:	
*Commissioned by:	
*Commissioner's address: ...	
*Commissioner's email:	
Commissioner's phone no.: ..	
*Installation date:	DD – MM – YYYY

Installation meets the manufacturer's installation instructions: yes no

If the installation does not comply installation instruction values, customer and Metos have to be notified immediately about possible deviations.

We confirm the installation was done according to the attached installation checklist, the installation instructions and all national and local standards which ever may apply. The equipment was handed over free of defects. Operation and maintenance of the equipment was explained.

Sign/Date
Commissioner

Sign/Date
Customer

We reserve all rights in this document and in the information contained therein. Reproduction, use or disclosure to third parties without express authority is strictly forbidden.

© Copyright 2019 Metos Oy Ab

metos		Document type Review	Document ID DOC000650	Revision A	Page(s) 2(4)
Owner organization Metos Manufacturing		Created by	Date 2019-08-19	Status Ready	
Country FI	Department	Document title Installation/commissioning checklist for Metos kettles	Approved by	Security level Confidential	

PRINTED PAPER COPY IS UNCONTROLLED - PAPERITULOSTE ON VALVOMATON KOPIO

1. Physical installation:

Installation type: surface installation frame
 subsurface installation frame
 free standing

Free standing installation flanges: yes no
 Floor fixing bolts (min. 150mm and stainless steel) in surface standard chemical
 installation:
 Single or group installation: single group
 Installation frames filled with acrylic filling: yes no

2. Important perimeter clearances of all kettles:

	measurement:	
Support pillar (left) height:	[mm]	(900mm)
Control pillar (right) height:	[mm]	(992mm)
From support/control pillar without front plate to back wall/obstacle:	[mm]	(Dim. M, see installation manual)
Width from pillar to pillar:	[mm]	(L1 single/L2 group, see installation manual)

Height for lid opening OK: yes no

3. Levelling & tilting bearings

Free standing installation is made according to installation manual: yes no N/A
 Pillars and kettle are aligned vertically/horizontally: yes no
 Tilting bearing locks are checked: yes no

4. Electric connections

Measured voltages [V]:	L1-L2	L1-L3	L2-L3	L1-N	L2-N	L3-N	N-PE
.....							

Breaker size/fuse rating [A]:

Measured amps per phase [A]: L1 L2 L3
 (Full heating, no mixing)

Kettle connected to equipotential bonding: yes no
 Indicated voltage on the rating plate corresponds with measured yes no
 voltage:

We reserve all rights in this document and in the information contained therein. Reproduction, use or disclosure to third parties without express authority is strictly forbidden.

© Copyright 2019 Metos Oy Ab

metos		Document type Review	Document ID DOC000650	Revision A	Page(s) 3(4)
Owner organization Metos Manufacturing		Created by	Date 2019-08-19	Status Ready	
Country FI	Department	Document title Installation/commissioning checklist for Metos kettles	Approved by	Security level Confidential	

PRINTED PAPER COPY IS UNCONTROLLED - PAPERITULOSTE ON VALVOMATON KOPIO

5. Water connections

Cold/hot water supply equipped with non-return and shut-off valves: yes no

Cold-water dynamic pressure min. 250 kPa – max. 600 kPa;

measured value: [kPa]

Max. chloride (CL-) < 60mg/l (if higher → deionization treatment): yes no

Max. chlorine (CL₂) < 0,2mg/l (if higher → carbon filter treatment): yes no

Ph between 6,5 – 9,5: yes no

Conductivity < 1000µS/cm: yes no

Water treatment system used: yes no

If yes, manufacturer/type:

Water total hardness calculated from calcium (lime) and magnesium rate.

Too low total hardness rate can cause corrosion < 0,5 d° if chloride rate is high.

6. External cooling systems

Kettle connected with external cooling system (ice-bank etc.): yes no

If yes, installation company:

If yes, kettle manometer value when cooling: [bar] (max. 1,3bar)

Kettle equipped with pressurized air emptying: yes no

If yes, kettle manometer value when emptying: [bar] (max. 1,3bar)

Measured cooling water flow: [l/min]

7. Procedures after installation

Rotation direction of hydraulic tilting pump motor (counterclockwise): yes no N/A

Kettle up/down end limit switches working (kettle empties) and adjusted: .. yes no N/A

Mixer rotating direction checked (clockwise): yes no N/A

Lid and safety grid switches OK: yes no

Date and time (option) set and checked: yes no N/A

Safety valve test executed (electric heated → panel/direct steam → valve): yes no

8. Function test/commissioning:

All electrical connections and plugs are tight: yes no

All water connections tight and no leakages: yes no

All steam connections tight and no leakages (direct steam kettles): yes no

Cooling media circulation tight and no leakages (if closed circuit): yes no

All standard functions operational: yes no

All additional functions/features operational (HACCP, cooling etc.): yes no

Customer advised in daily cleaning routine: yes no

User/customer advised in preventative maintenance yes no

(safety valve test executed 4 times/year etc.):

We reserve all rights in this document and in the information contained therein. Reproduction, use or disclosure to third parties without express authority is strictly forbidden.

© Copyright 2019 Metos Oy Ab

PRINTED PAPER COPY IS UNCONTROLLED - PAPERITULOSTE ON VALVOMATON KOPIO

9. Direct steam kettles:

 Steam pressure regulator valve; set pressure: [bar] (max. 1bar)
 Steam pressure regulator valve; distance from kettle: [m] (min. 15m) *)

*) If not pilot guided valve, min. 10m.

 Steam trap (condensation remover) before kettle; [m] (max. 2m) **) distance:

 Steam line installed according to installation manual: yes no

 Steam line safety valve set pressure: [bar] (max. 1,3bar)

 Steam line safety valve after regulator valve: yes no

 Steam line particle filter: yes no

 Non-return valve steam line installed if cooling: yes no **)

 Steam line insulated: yes no

 Free flow in condensation line: yes no **)

 Condensation line going downwards, min. 3°: yes no **)

 Non-return valve condensation line installed: yes no **)

**) If no, contact factory.

Comments:

Revision history

Revision	Page (P) Chapter (C)	Description	Date	Name/ Department
A	-	Original version	2019-08-19	

Return to your dealer.

Registration form for units "Dead on Arrival" (DoA)		
Reported by subsidiary:		Reported by (Name):
Equipment type and serial no:	Installation date:	Date when fault occurred:
Customer's address:	Service company contacts / technician who reported the fault:	
Fault description:		
Measured supply voltages: L1: L2: L3:		
Fault remedy (if repaired) + service parts used/exchanged:		
<u>Please return following material/data in any case as soon as possible:</u>		
Service parts that are exchanged with parcel service:		Tracking number:
<ul style="list-style-type: none">- Service data- HACCP data- Log file- Pictures		
Address for parts: Metos Oy Ab Ahjonkaarre FI-04220 Kerava FINLAND		



Valmistajan nimi / Tillverkarens namn / Manufacturer's name

METOS OY AB

Osoite / Adress / Address

04220 KERAVA
FINLAND

Vakuuttaa, että seuraava tuote / Försäkrar att följande produkt / Declare that the following product

Nimi, tyyppi tai malli / Namn, typ eller modell / Name, type or model

Patasarjat / Grytsserierna / Kettle series **METOS PROVENO 4G(+)** / **METOS CULINOPRO** / **METOS VIKING 4G** sähkö- tai hörylämmiteinen / el- eller ånguppvärmd / electrically or steam heated.
Mallit / Modeller / Models : 40, 60, 80, 100, 150, 200, 300, 400 / E, S / H / M / Sous Vide
Varustepaketit / Optionspaket / Option sets: T, C1, C2, C3i, C5i, PA, S1, S2, S3, D1, D2, HA, DO, W, FP, JF, PS, HG, TD, HF, RJ, WM

on seuraavien direktiivien asiaankuuluvien säännösten mukainen / överensstämmer med tillämpliga bestämmelser i följande direktiv / is in conformity with the relevant provisions of the following directives

MD 2006/42/EC, LVD 2014/35/EU, EMC 2014/30/EU, RoHS 2011/65/EC, WEEE 2012/19/EU, PED 2014/68/EU, moduulit / modelerna / modules B + D

- SEP: 40 – 60 höry/ånga/steam
- Cat I: 40 – 60 sähkö/el/electric, 80 – 400 höry/ånga/steam
- Cat II: 80 – 400 sähkö/el/electric

HUOM: PED 2014/68/EU:n mukaisesti vaatimustenmukaisuusvakuutus ja CE-merkintä ei koske SEP luokiteltuja laitteita.

OBS: Enligt PED 2014/68/EU försäkran om överensstämmelse och CE-märkningen ej produkter i SEP kategorin.

ATT: According to PED 2014/68/EU the declaration of conformity and the CE-marking does not apply to SEP category products.

ja lisäksi vakuuttaa, että seuraavia yhdenmukaistettuja standardeja (tai niiden osia/kohtia) on sovellettu / och försäkrar dessutom att följande harmoniserade standarder (eller delar/paragrafer) har använts / and furthermore declares that the following harmonised standards (or parts/clauses) have been used

EN ISO 12100:2010, EN ISO 13857:2019, EN 61000-6-1:2019, EN 61000-6-3:2007
EN 60204-1:2018, EN 13445:1...5:2021

ja lisäksi vakuuttaa, että seuraavia muita standardeja (tai niiden osia/kohtia) on sovellettu / och försäkrar dessutom att följande andra standarder (eller delar/paragrafer) har använts / and furthermore we declare that the following other standards (or parts/clauses) have been used

EN 13886:2005+A1:2010, EN 1717:2001, Regulation (EC) No 1935/2004, EN 16851:2017 + A1:2020 (Sous Vide)

Tuotteen suunnitelmataarkastustodistus ja laatuajärjestelmää valvova ilmoitettu laitos (vain painelaitteet)
Produktens konstruktionskontrollcertifikat och anmält organ, som övervakar kvalitetssystemet (endast tryckkärl)
Product design examination certificate and the notified body supervising the quality system (only pressure vessels)

Quality system (D-module)
Kiwa Tarkastus Oy, Helsinki, Finland
0424DA-22-131824 (4E, 4S, 6E, 6S),
DA-22-131804 (8E, 8S, 10E, 10S),
DA-22-131764 (15E, 15S, 20E, 20S),
DA-22-131728 (30E, 30S, 40E, 40S)
DEKRA Industrial Oy, Vantaa, Finland 0875

Alla mainittu henkilö on valtuutettu kokoamaan teknisen tiedoston / Nedan nämnda person är bemyndigad att sammanställa den tekniska dokumentfilen / The person mentioned below is authorized to compile the technical file

Tero Kähärä Metos Oy Ab, Ahjonkaarre, 04220 Kerava, Finland

Tämä vaatimustenmukaisuusvakuutus on annettu valmistajan yksinomaisella vastuulla. Edellä kuvattu vakuutuksen kohde on unionin asiaankuuluvan yhdenmukaistamislainsäädännön vaatimusten mukainen.

Denna EU-försäkran om överensstämmelse utfärdas på tillverkarens eget ansvar. Föremålet för försäkran ovan överensstämmer med den relevanta unionslagstiftningen om harmonisering.

This declaration of conformity is issued under the sole responsibility of the manufacturer. The object of the declaration described above is in conformity with the relevant Union harmonisation legislation

Antopaikka ja päivä / Utfärdad på ort och datum / Place and date of issue

KERAVA 30.12.2024

Vakuutuksen antajan nimi ja asema / Namn och befattning av personen som försäkrar / Name and title of declaring person

Hannu Ahola – Director of Business Unit

Risto Koskelainen – R&D Manager

Metos Oy Ab

Ahjonkaarre, 04220 Kerava, Finland

Tel. +358 204 3913

metos.finland@metos.fi

www.metos.com

metos
kitchen intelligence®